

TA-AX3

479 AS
81014

AEP Model
UK Model
E Model

Outputs:
REC OUT 1, 2
Voltage 180 mV
Impedance 4.7 k Ω
SPEAKER A, B
Accepts speakers of 4 - 16 Ω
HEADPHONES
Accepts low and high impedance headphones

Tuner:
TUNER
AUX 5 Hz - 45 kHz \pm 0.5 dB
Tape 1, 2
Less than 140 mV (8 Ω network A)
60 (8 Ω , 1 kHz)

Tone Controls:
BASS
+10 dB at 100 Hz (turnover frequency 200 Hz)
TREBLE
+5 dB at 25 kHz (turnover frequency 8 kHz)
+3 dB at 10 kHz

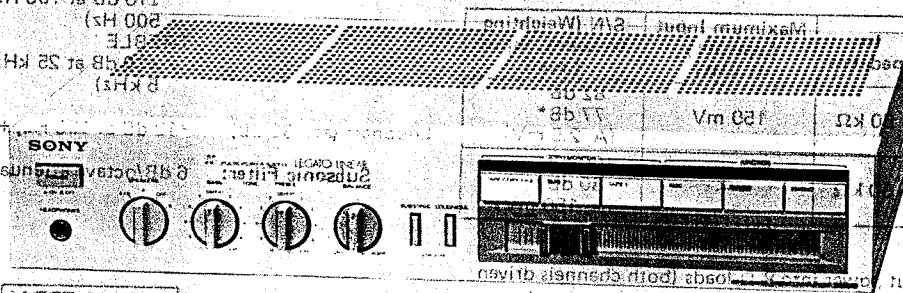

Inputs:	PHONO	2.5 mV	0 k Ω
	TUNER	180 mV	0 k Ω
	TAPE 1, 2	180 mV	0 k Ω
	HEADPHONE	180 mV	0 k Ω

0 dB = 0.775 V

INTEGRATED STEREO AMPLIFIER

SPECIFICATIONS

GENERAL

System: Preamplifier section: low-noise NF type equalizer amp.; NF type tone control
Power amplifier section: pure-complementary SEPP dc power amplifier with all stages direct coupled

Power Requirements: AEP model: 220 V ac, 50 Hz/60 Hz
UK model: 240 V ac, 50 Hz/60 Hz
E model: 110, 120, 220 or 240 V ac adjustable, 50/60 Hz

Power Consumption:

AEP, E model: 75 watts
UK model: 250 watts

Dimensions:

Approx. 430(w) x 80(h) x 330(d) mm
(17(w) x 3 $\frac{1}{4}$ (h) x 13(d) inches)
including projecting parts and controls

Weight:

Approx. 4.2 kg (9 lbs 4 oz) net
Approx. 5.0 kg (11 lbs) in shipping carton

AMPLIFIER SECTION

Continuous RMS Power Output:

(Less than 0.008 % THD, both channels driven simultaneously)
At 20 Hz - 20 kHz
40 + 40 watts (8 Ω)
According to DIN 45500
40 + 40 watts (8 Ω)

Power Bandwidth (IHF):

5 Hz - 40 kHz

Dynamic Headroom:

1.0 dB*

Harmonic Distortion:

Less than 0.008 % at rated output

Intermodulation (IM) Distortion:

(60 Hz : 7 kHz = 4 : 1)
Less than 0.008 % at rated output

SAFETY-RELATED COMPONENT WARNING!!

COMPONENTS IDENTIFIED BY SHADING AND MARK \triangle ON THE SCHEMATIC DIAGRAMS, EXPLODED VIEWS AND IN THE PARTS LIST ARE CRITICAL TO SAFE OPERATION. REPLACE THESE COMPONENTS WITH SONY PARTS WHOSE PART NUMBERS APPEAR AS SHOWN IN THIS MANUAL OR IN SUPPLEMENTS PUBLISHED BY SONY.

WARNING!!

THIS SET USES THE SWITCHING-TYPE POWER-SUPPLY CIRCUIT, WHICH IS DIRECTLY CONNECTED TO THE AC POWER LINE. AN ISOLATION TRANSFORMER SHOULD BE USED DURING ANY SERVICE TO AVOID POSSIBLE SHOCK HAZARD.



SONY

SERVICE MANUAL

- Continued on page 2 -

139c

Frequency Response: PHONO RIAA equalization curve ± 0.2 dB
 TUNER
 AUX 5 Hz - 45 kHz ± 1 dB
 TAPE 1, 2

Residual Noise: Less than 140 μ V (8 Ω , network A)

Damping Factor: 50 (8 Ω , 1 kHz)

Inputs:

	Sensitivity	Im- pedance	Maximum Input Capability (1 kHz)	S/N (Weighting Network, Input Level)
PHONO	2.5 mV	50 k Ω	150 mV	82 dB 77 dB* (A, 2.5 mV)
TUNER AUX TAPE 1, 2	150 mV	50 k Ω	-	100 dB 80 dB* (A, 150 mV)

* '78 IHF

Measured with rated output power into 8 Ω loads (both channels driven simultaneously) at 1 kHz.

Outputs: REC OUT 1, 2
 Voltage 150 mV
 Impedance 4.7 k Ω .
 SPEAKER A, B
 Accepts speakers of 4 - 16 Ω .
 HEADPHONES
 Accepts low and high impedance headphones.

Tone Controls: BASS
 ± 10 dB at 100 Hz (turnover frequency 500 Hz)
 TREBLE
 ± 10 dB at 25 kHz (turnover frequency 5 kHz)

Loudness (att. 30 dB): +10 dB at 100 Hz, +3 dB at 10 kHz

Subsonic Filter: 6 dB/octave attenuation below 15 Hz

$0 \text{ dB} = 0.775 \text{ V}$

MODEL IDENTIFICATION

- Specification Label -

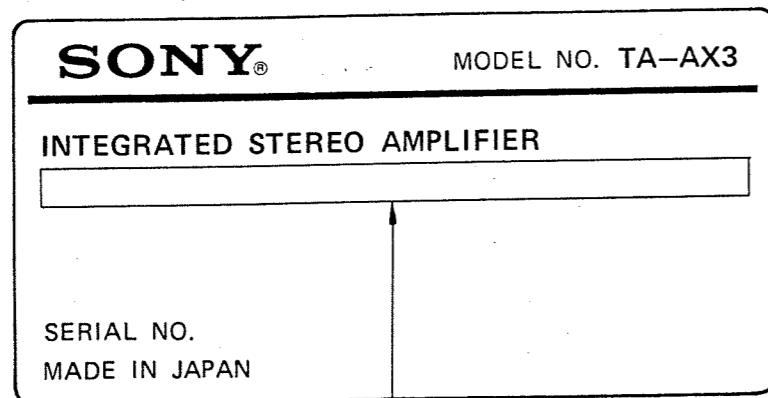

AEP model: AC 220V ~ 50/60Hz 75W
 UK model: AC 240V ~ 50/60Hz 250W
 E model: AC 110, 120, 220 or 240V, adjustable ~ 50/60Hz 75W

SERVICING NOTE

1. Pulse Power Supply Board Repairing

This set has a pulse power-supply circuit which is quite different from a conventional power-supply circuit. The pulse power-supply directly rectifies and smooths the ac input power to produce the higher dc voltages required in the power-supply circuit. When servicing this set, note the following.

- a) To prevent unwanted radiation due to pulse signals in the pulse power-supply circuit, the pulse power-supply board is shielded by the aluminum diecast box.
- b) Take care that electrolytic capacitor which is used after the rectification of ac power source voltage is charged even if the POWER switch is turned off. Be sure to use a resistor of at least several hundred ohms to discharge the capacitor. Direct discharge by means of lead is dangerous.

2. Inverter Circuit Transistor Replacement

When any of inverter transistors (Q903, Q904) is broken, replace their transistors together. A pair of transistors with the same rank is provided for service field use.

Ref. No.	Part No.	Description
Q903, Q904	X-4869-209-1	Transistor Ass'y, service

3. Inverter Circuit Transformer Replacement

The lead wire arrangement for each of T901 and T902 in the inverter circuit is shown in Fig. A. As the repair parts, T901 and T902 are formed by only iron core. Thus, if the coil is defective, arrange a new transformers as shown below. Note that the lead lengths must be exact. Also wind the coil carefully.

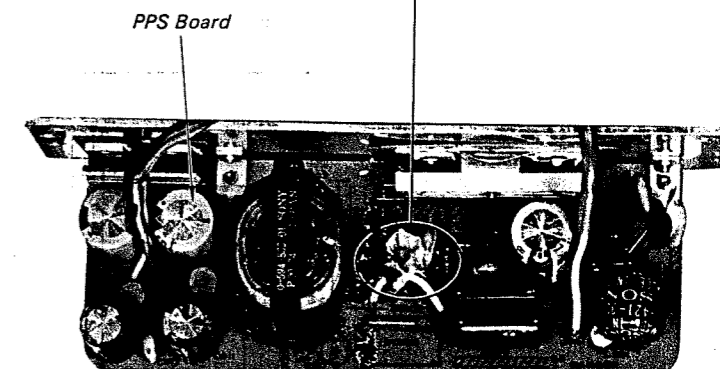
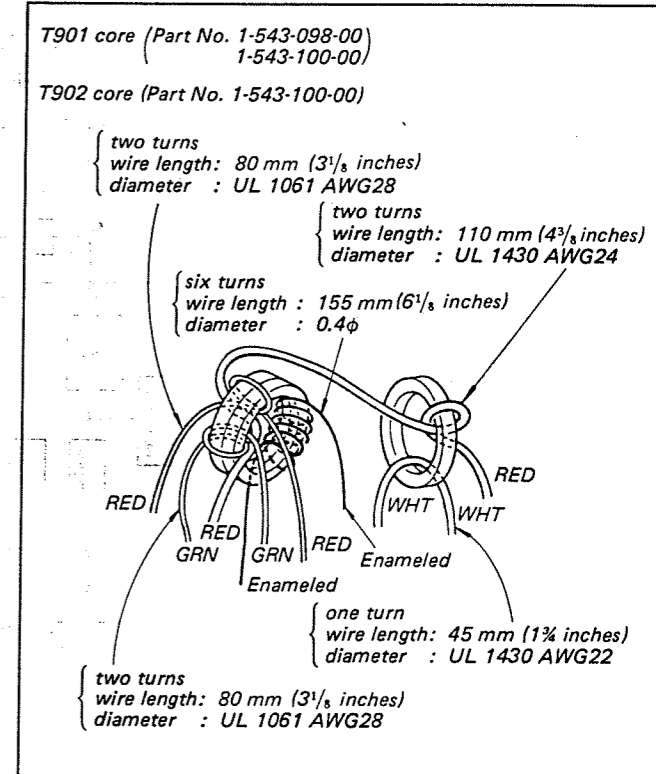

SECTION 1
BLOCK DIAGRAM

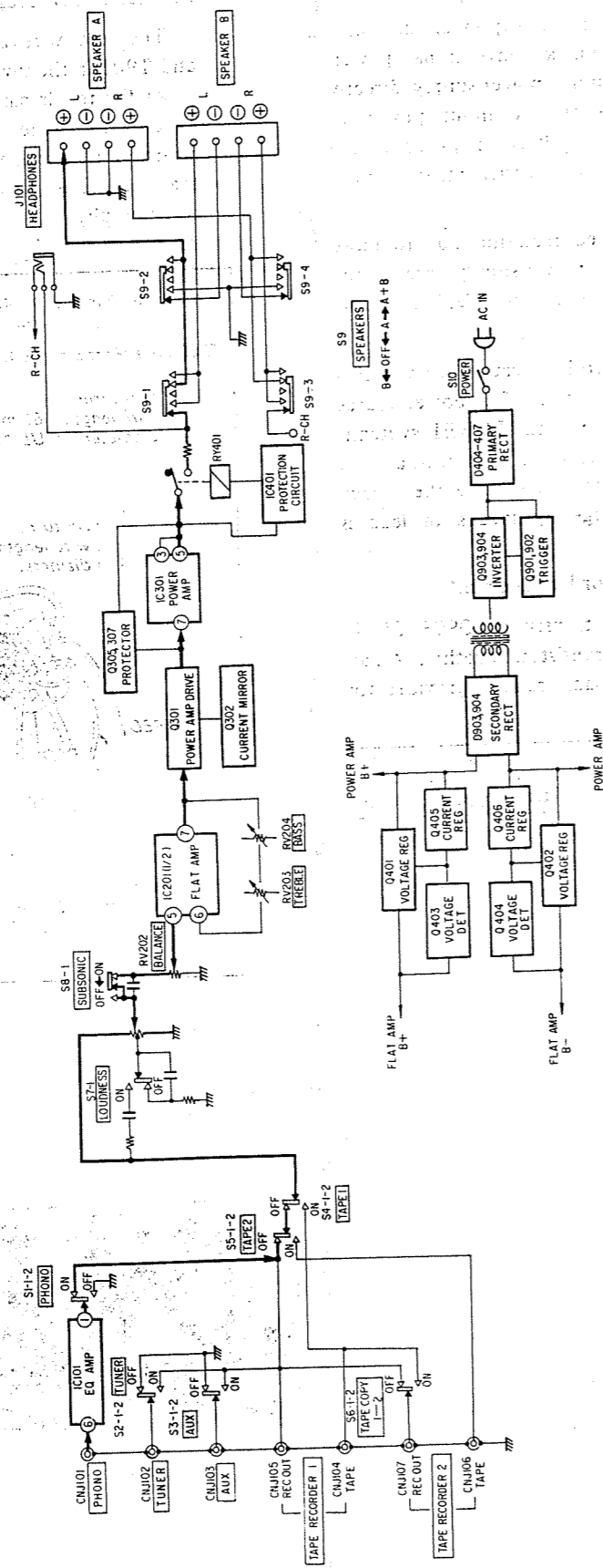

SECTION 2
DISASSEMBLY

Note: Follow the disassembly procedure in the numerical order given.

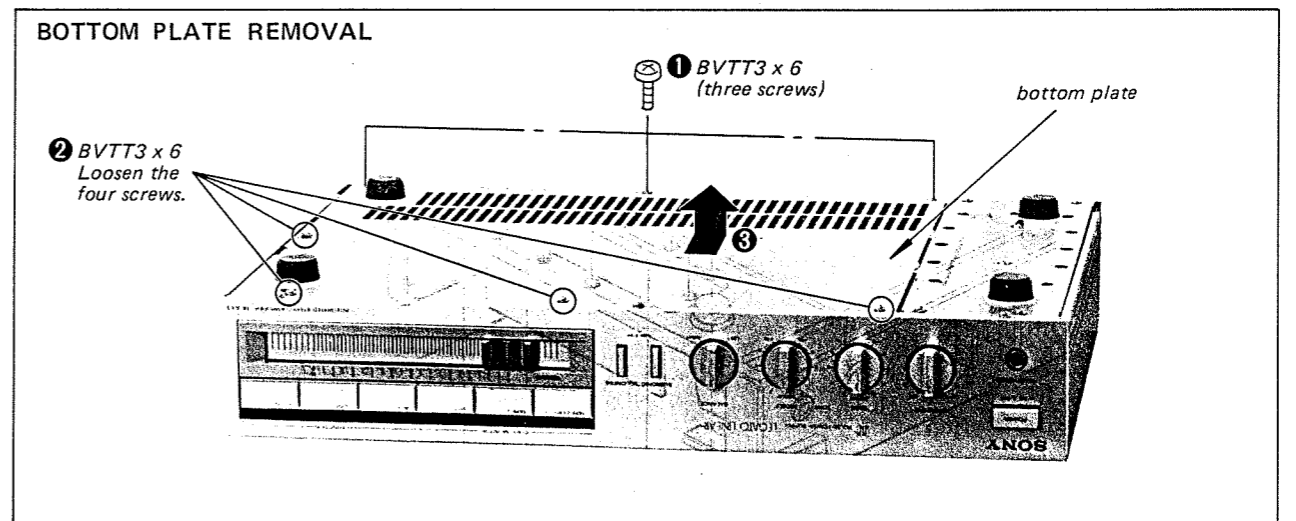
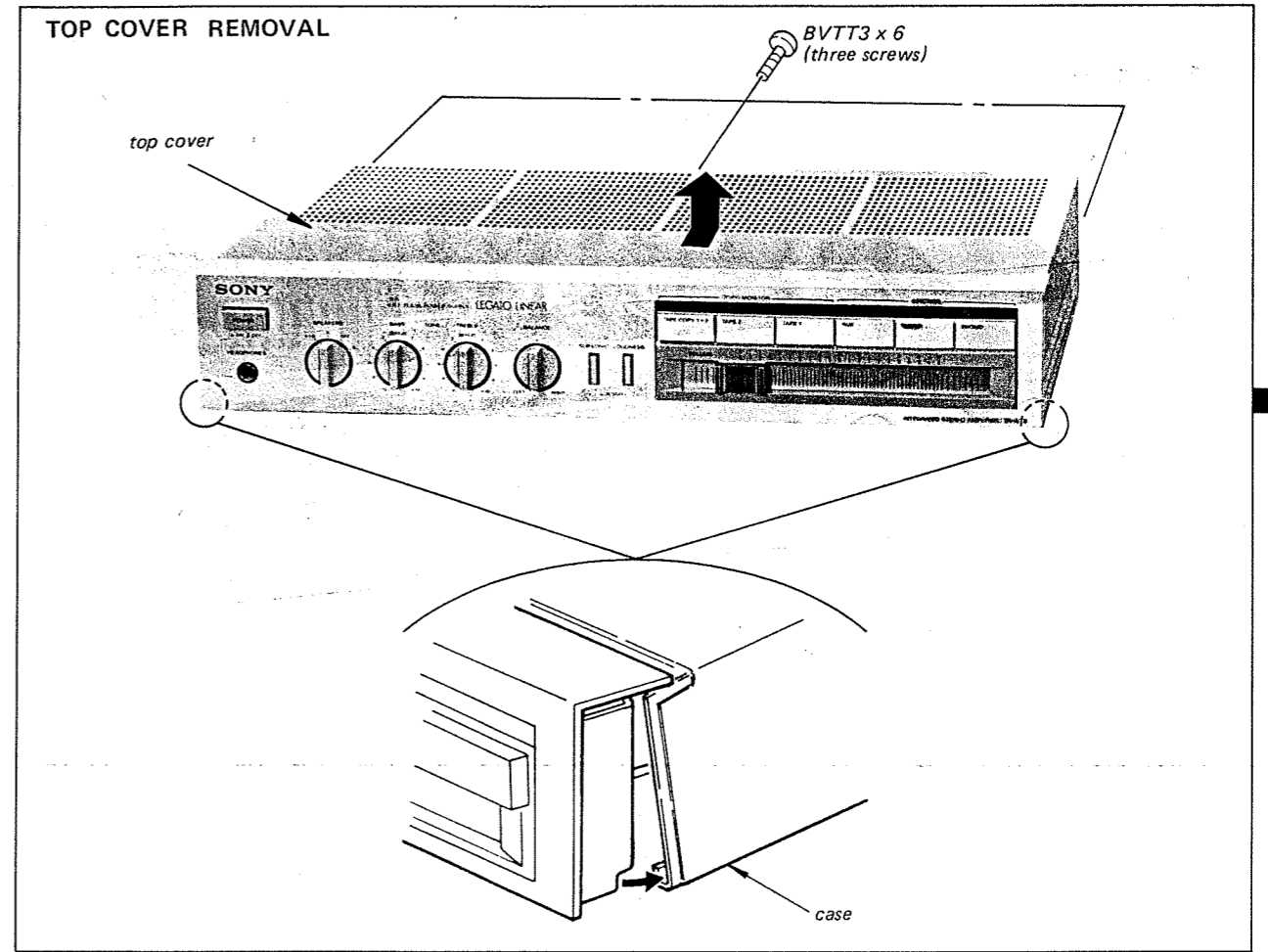

The conductor side of the audio circuit board can be checked in this condition.

PANEL REMOVAL

② BVT73 x 6
(three screws)

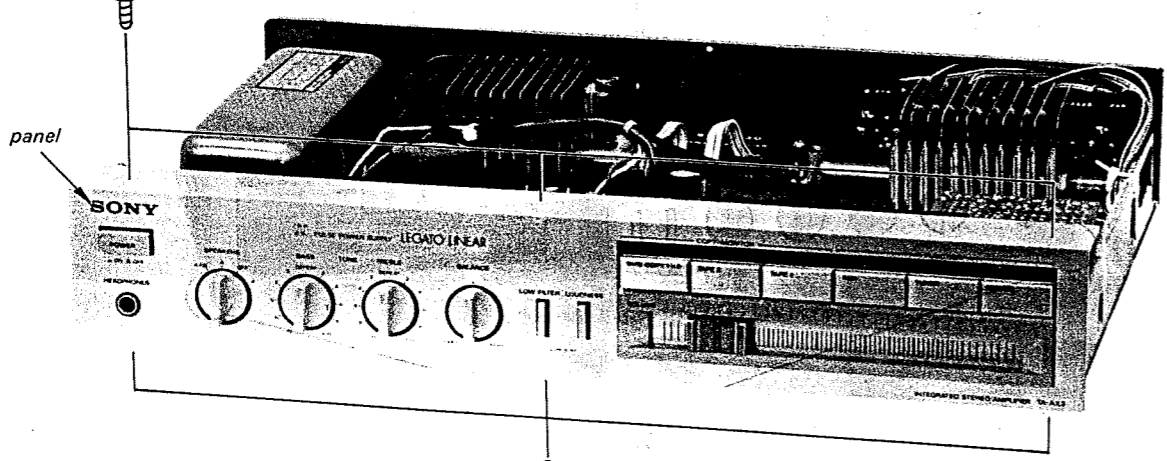

① BVT73 x 6
(three screws)

POWER BOX REMOVAL

Perform the pulse power supply board repairs with the power box removed so that the pulse power supply board is grounded.

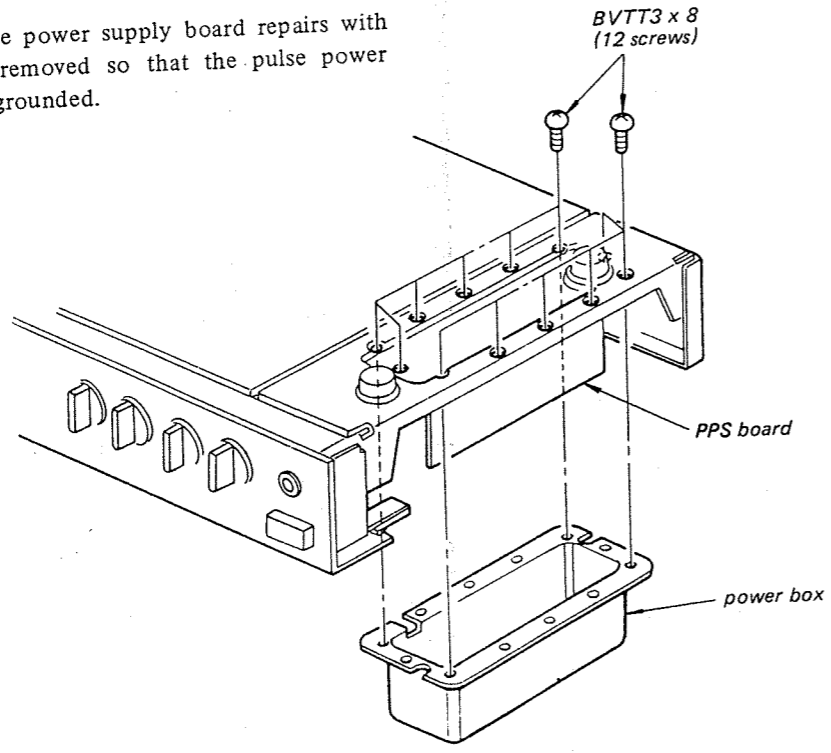

at DC BIAS confirmation and DC BALANCE adjustment two or three times.
replacing the power transistors, DC BIAS confirmation and DC BALANCE adjustment should be made.

- R-CH -

Confirm R363 for 0.6 V readings.

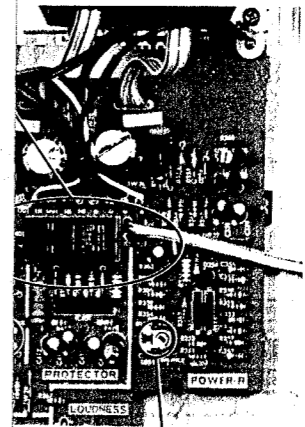
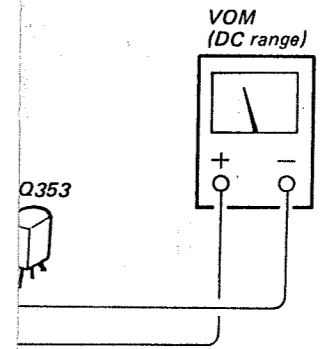

RT351
(R-CH)

RT301 (L-CH) and RT351 (R-CH) for 0V on the VOM.
the VOM high at first. After obtaining reading, lower the range gradually and at RT301 and RT351.
caution: 0 V ±50 mV

**SECTION 3
ADJUSTMENTS**

DC BIAS confirmation and DC BALANCE adjustment should be made several minutes later after the POWER switch is turned on (POWER ON).

Make DC BIAS confirmation first.

3. Repeat DC BIAS confirmation and DC BALANCE adjustment two or three times.

4. After replacing the power transistors, DC BIAS confirmation and DC BALANCE adjustment should be made.

DC Bias Confirmation (with no signal input)

— L-CH —

Confirm R313 for 0.6 V readings.

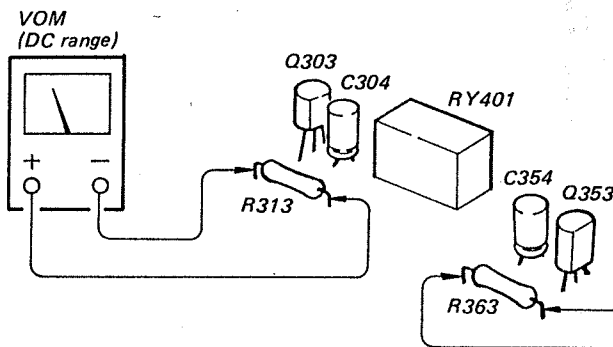

— R-CH —

Confirm R363 for 0.6 V readings.

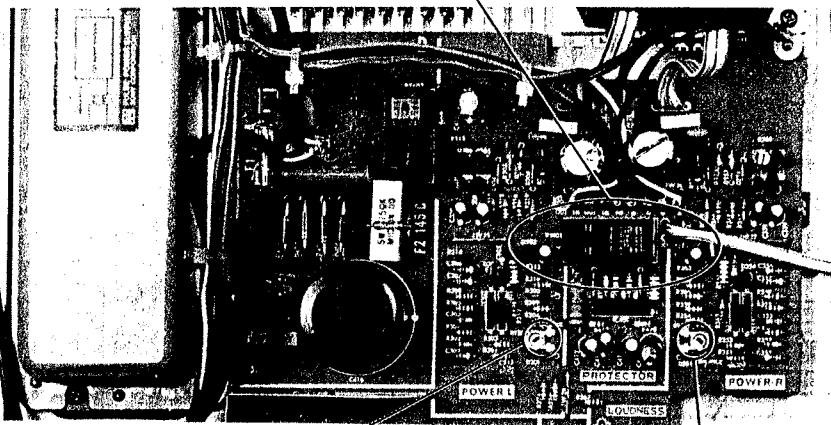
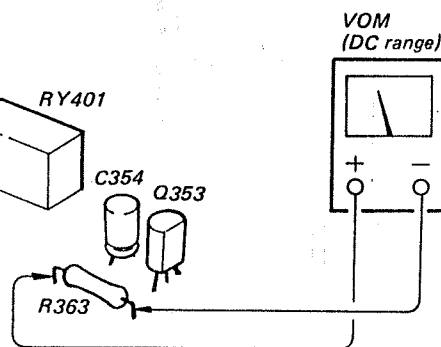

RT301
(L-CH)

RT351
(R-CH)

DC Balance Adjustment (with no signal input)

Turn the power switch ON. Connect a VOM to speaker terminals.

2. Adjust RT301 (L-CH) and RT351 (R-CH) for 0V reading on the VOM.

(Set the VOM high at first. After obtaining 0 V reading, lower the range gradually and adjust RT301 and RT351.)

Specification: 0 V ±50 mV

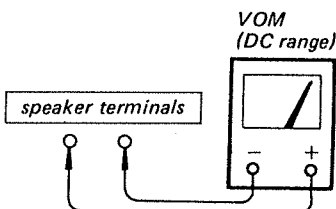

SECTION 4
DIAGRAMS

4-1. MOUNTING DIAGRAM — Audio and PPS Board (E Model) —
— Conductor Side —

Semiconductor Lead Layouts

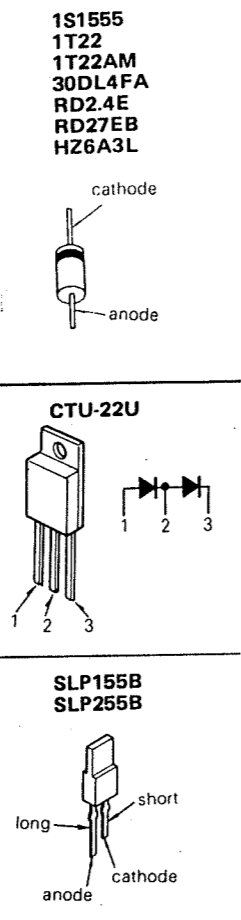
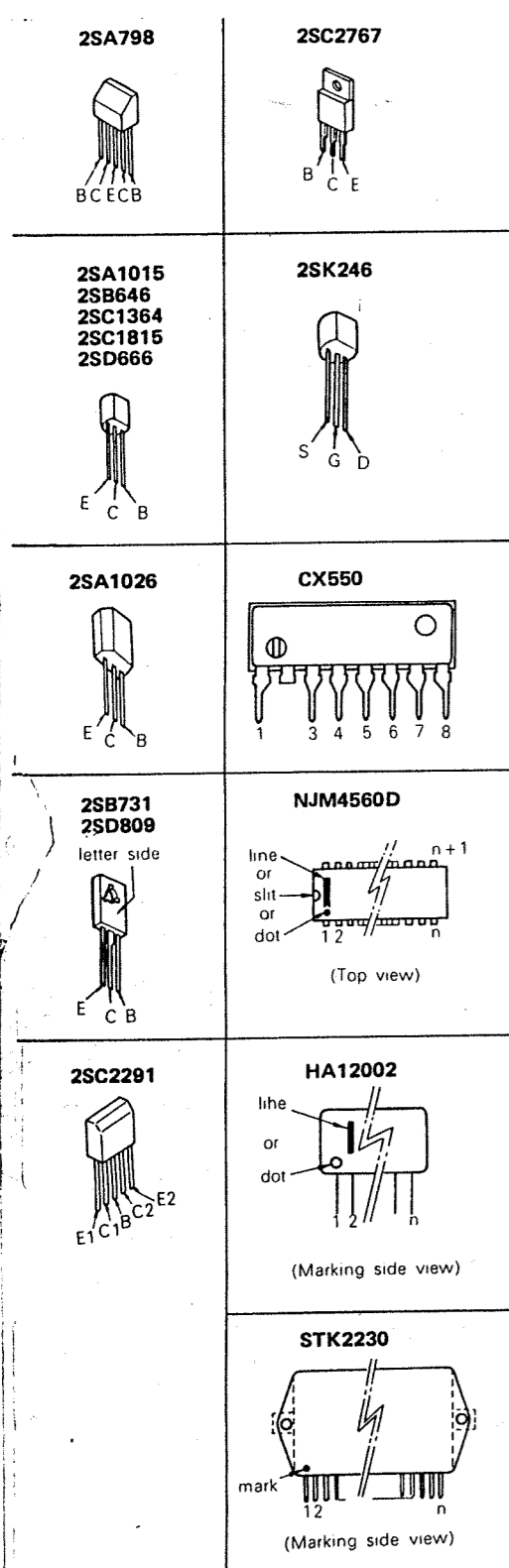

Note:

- Color code of sleeving over the end of the jacket.

- : B + pattern
- : B - pattern

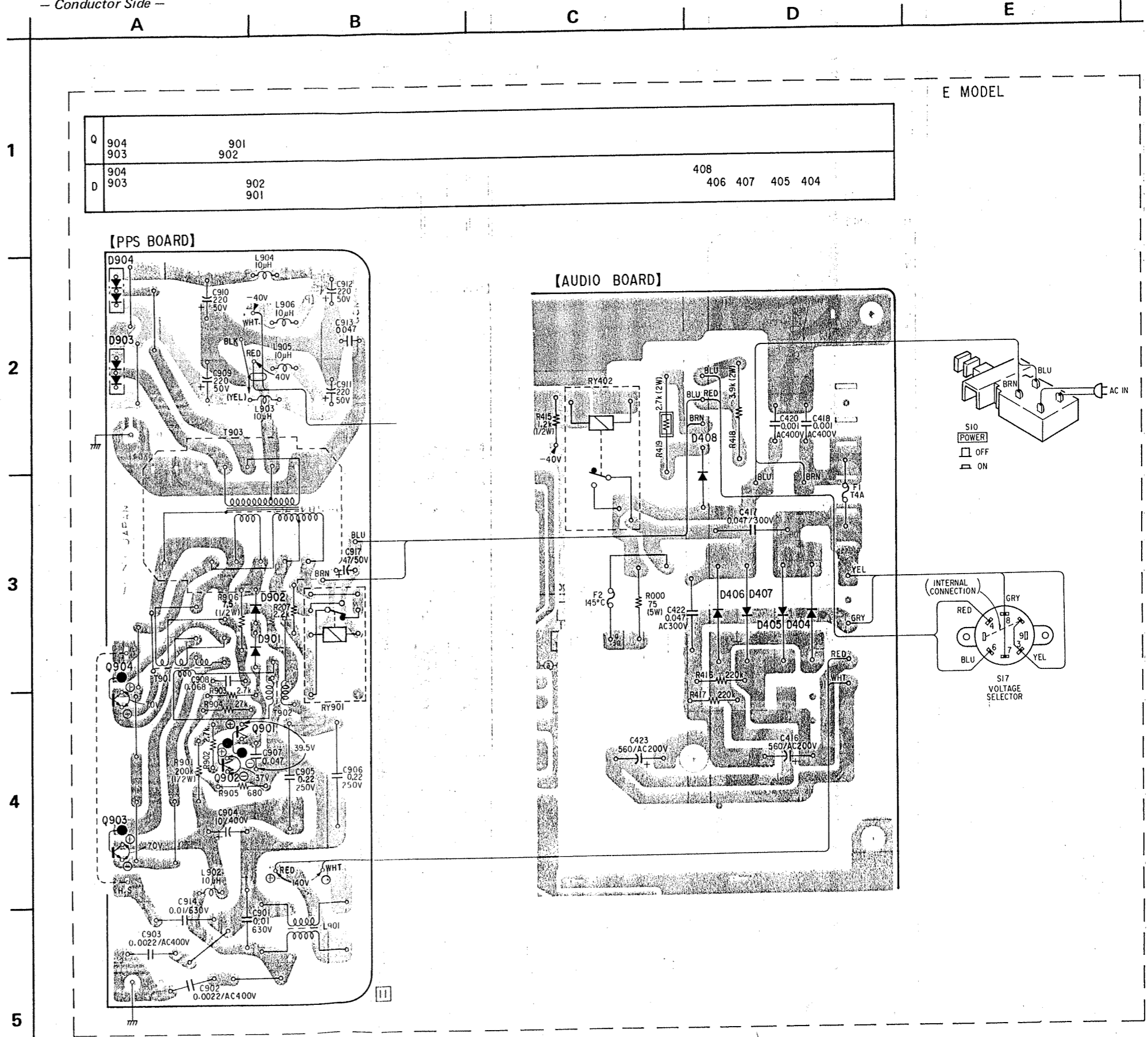

TA-AX3 TA-AX3

E F G H I J K

IC301 IC401	303	306, 305 304, 308 307 301, 302 IC201								405 403 404 406	401 402	IC101 IC151	Q IC
402	403	304, 305, 303 302 306	IC201	406 407 . 405 404	006	005	007 004	003	002	401	001		0

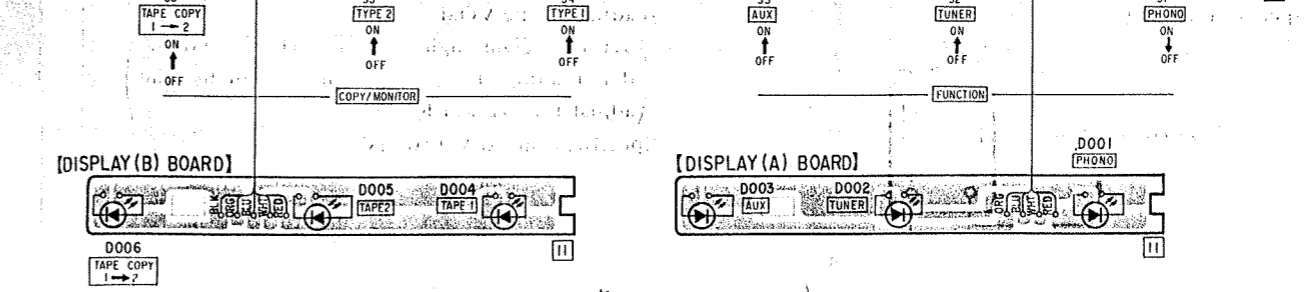
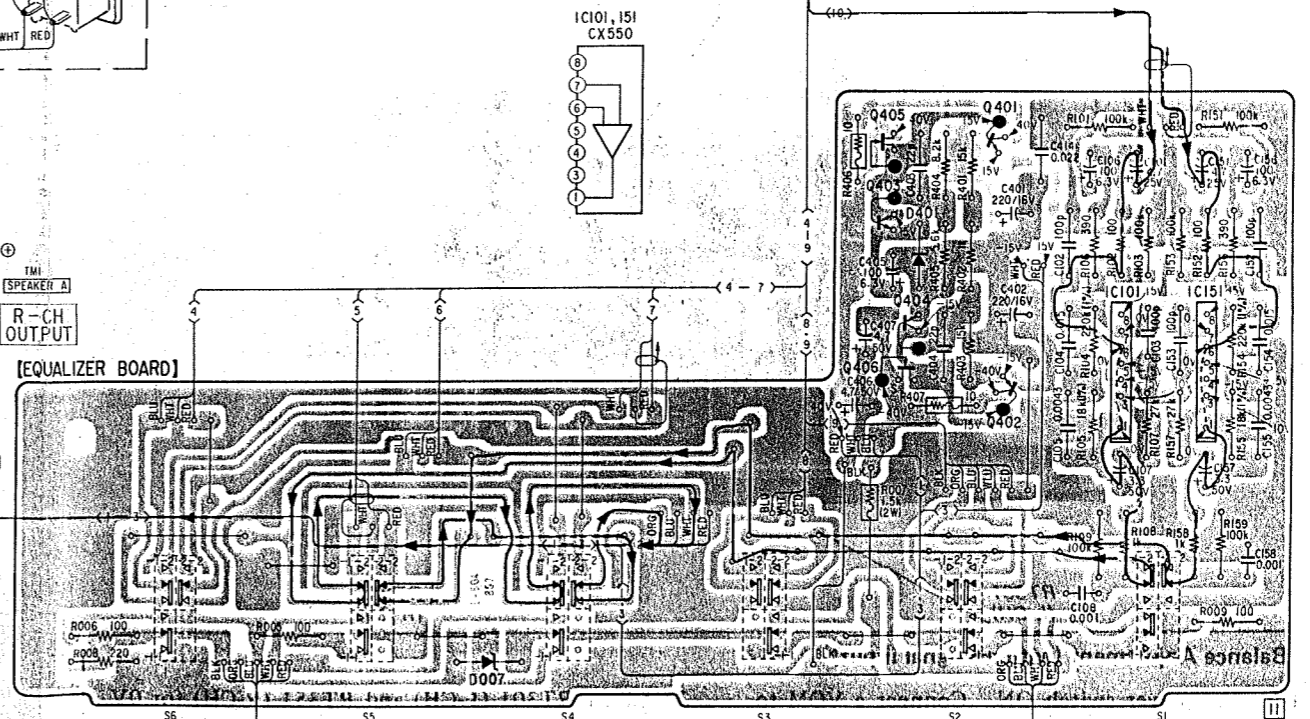
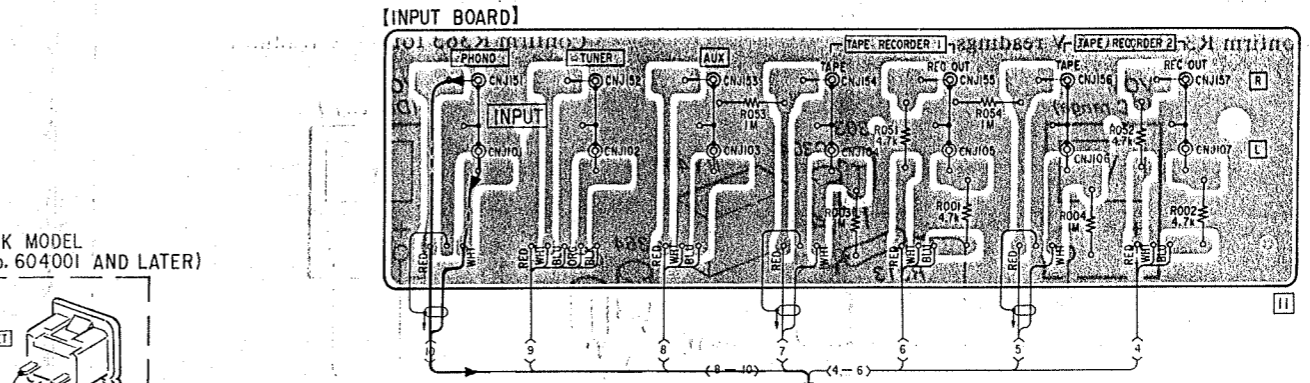
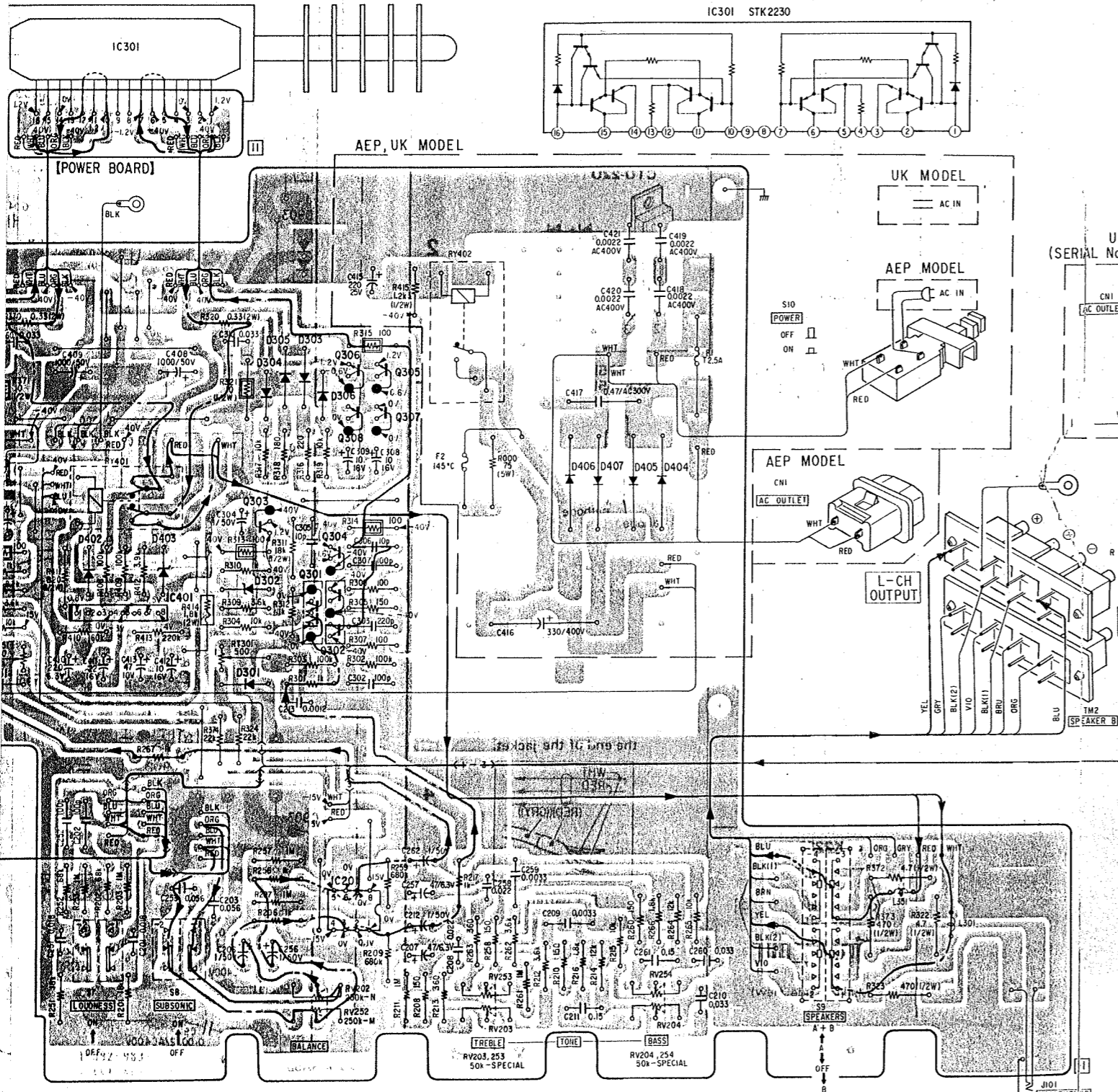

1
2
3
4
5

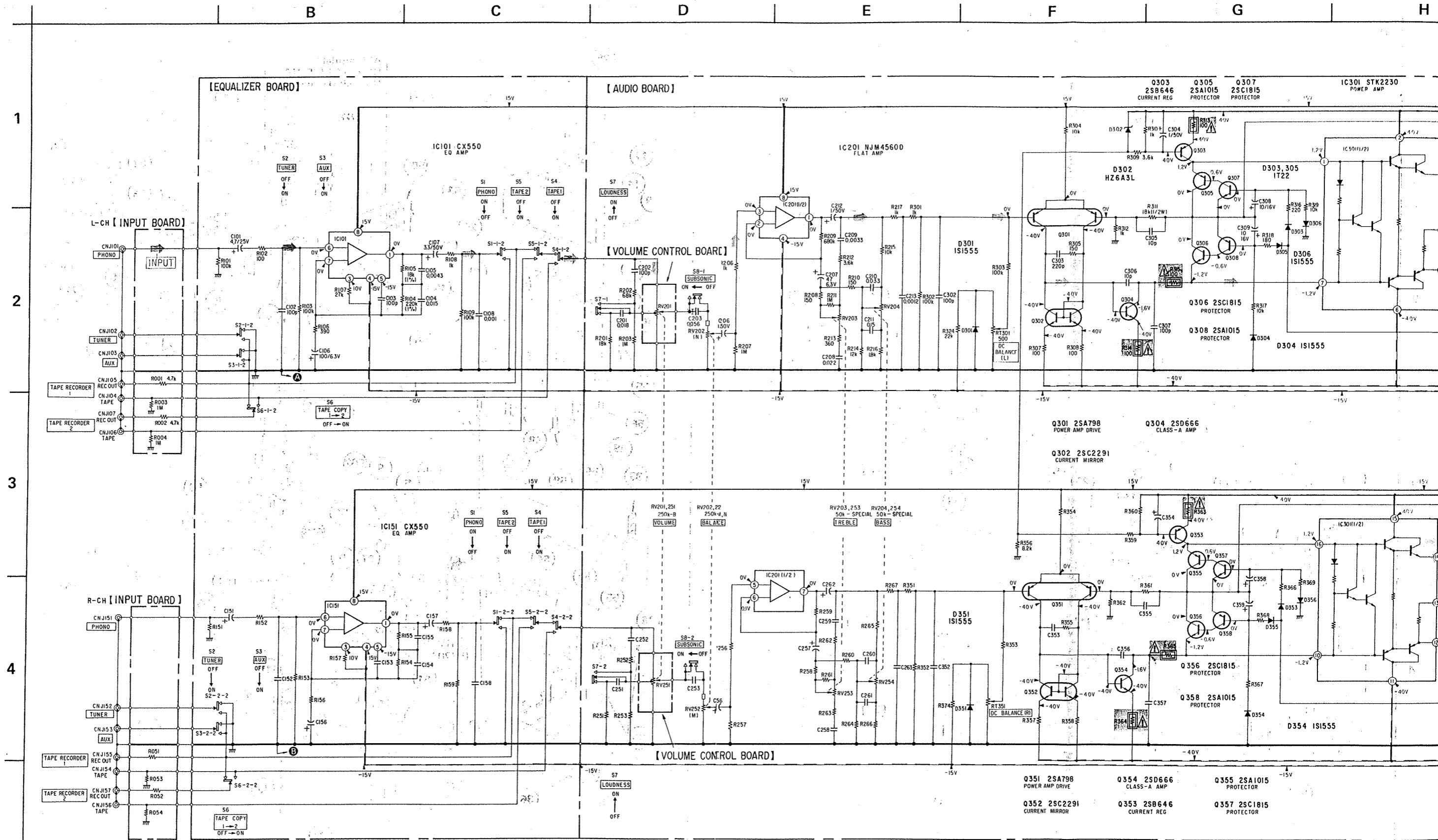

TA-AX3 TA-AX3

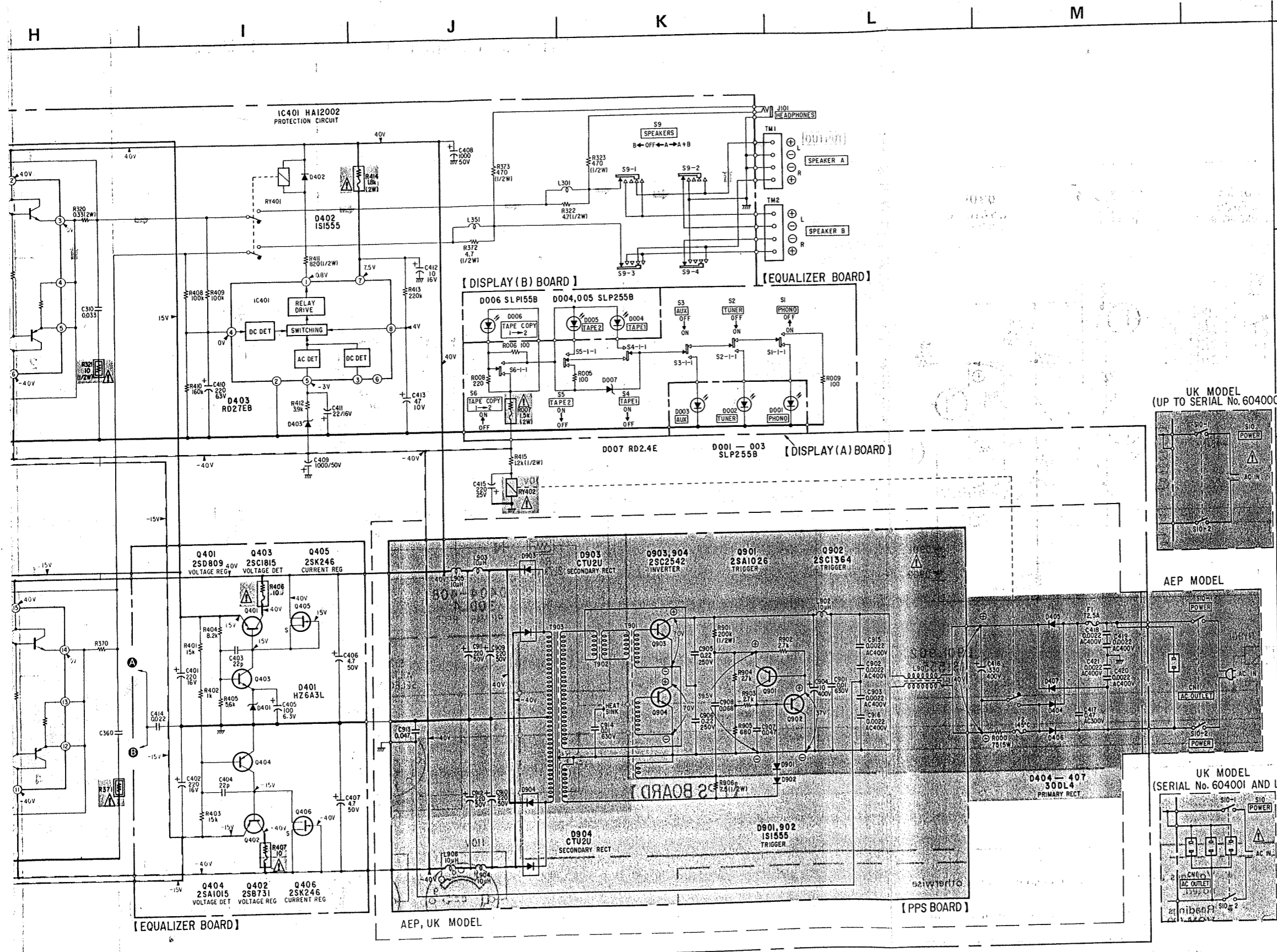

- Note:**
- All capacitors are in μF unless otherwise noted. $\text{pF} : \mu\text{F}$ 50WV or less are not indicated except for electrolytics and tantalums.
 - All resistors are in ohms, $\frac{1}{4}\text{W}$ unless otherwise noted. $\text{k}\Omega : 1000\Omega$, $\text{M}\Omega : 1000\text{k}\Omega$
 - : nonflammable resistor.
 - : fusible resistor.
 - : adjustment for repair.
 - : B+ bus.
 - : B- bus.
 - Voltages are dc with respect to ground unless otherwise noted.
 - Readings are taken under no-signal conditions with a VOM (20 $\text{k}\Omega/\text{V}$).
 - Voltage variations may be noted due to normal production tolerances.

Switch

Ref. No.	Switch	Position
S1	PHONO	ON
S2	TUNER	OFF
S3	AUX	OFF
S4	TAPE 1	OFF
S5	TAPE 2	OFF
S6	TAPE COPY 1→2	OFF
S7	LOUDNESS	OFF
S8	SUBSONIC	OFF
S9	SPEAKERS	A
S10	POWER	OFF

Note: The components identified by shading and mark are critical for safety. Replace only with part number specified.

• : signal path

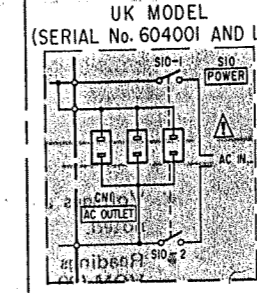
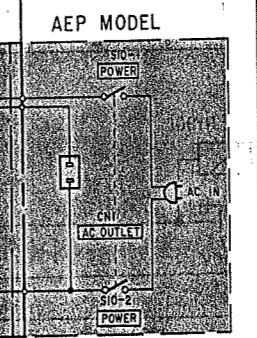
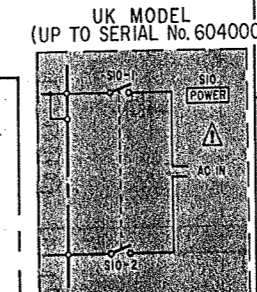

TA-AX3 TA-AX3

4.4. SCHEMATIC DIAGRAM — Audio and PPS Board (E Model) —

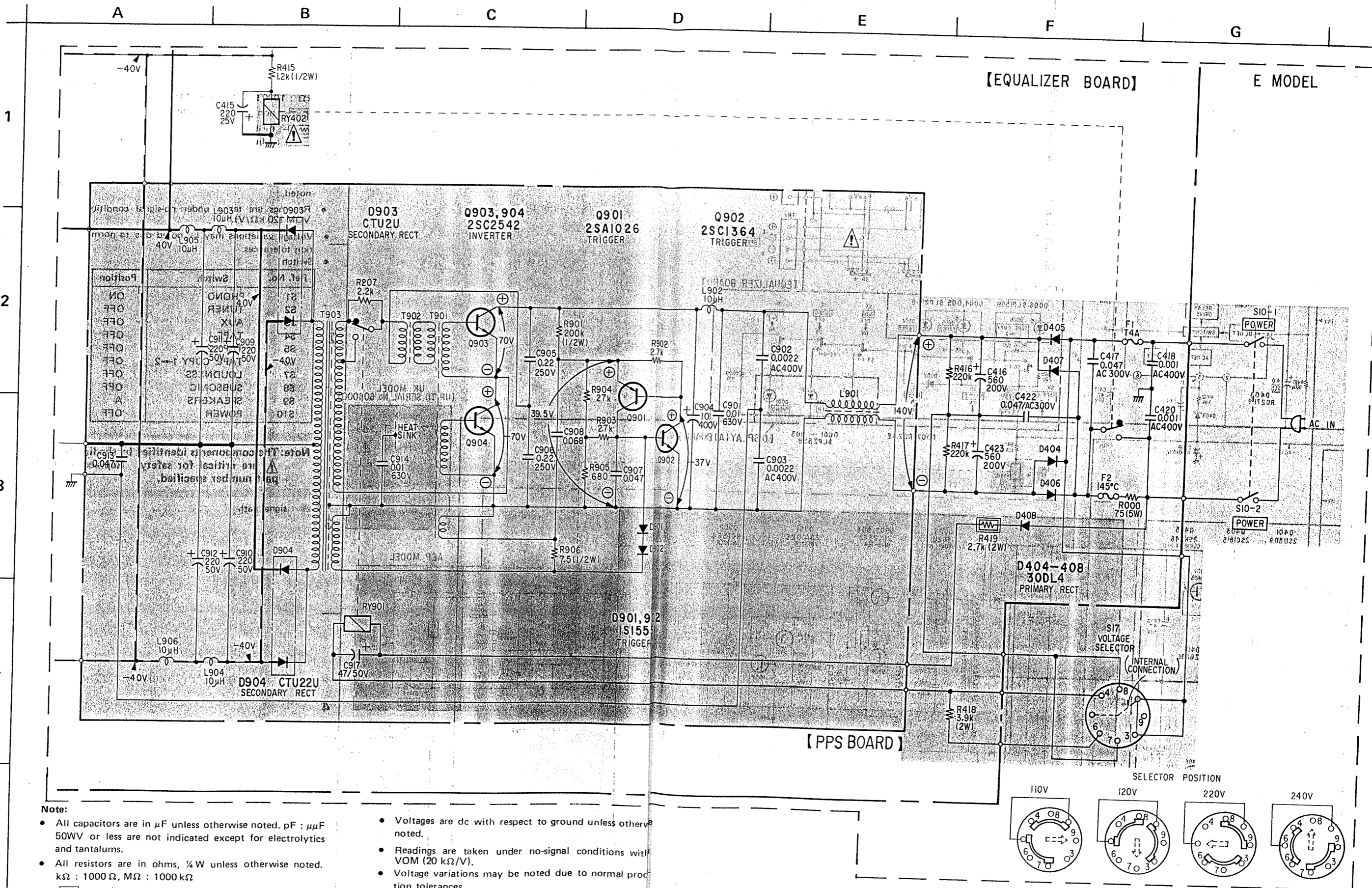

Note:

- All capacitors are in μF unless otherwise noted. $\text{pF} : \mu\text{F}$ 50WV or less are not indicated except for electrolytics and tantalums.
- All resistors are in ohms, $\frac{1}{2}\text{W}$ unless otherwise noted. $\text{k}\Omega : 1000\Omega$, $\text{M}\Omega : 1000\text{k}\Omega$
- : nonflammable resistor.
- : B+ bus.
- : B- bus.

- Voltages are dc with respect to ground unless otherwise noted.
- Readings are taken under no-signal conditions with VOM (20 $\text{k}\Omega/\text{V}$).
- Voltage variations may be noted due to normal production tolerances.

Note: The components identified by shading and are critical for safety. Replace only with part number specified.

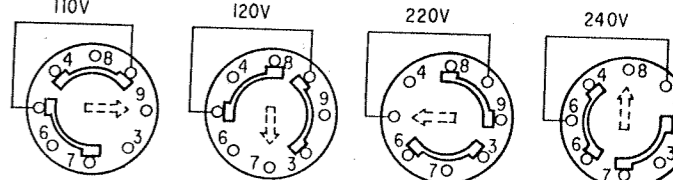

5

SECTION 5
EXPLODED VIEWS AND PARTS LIST

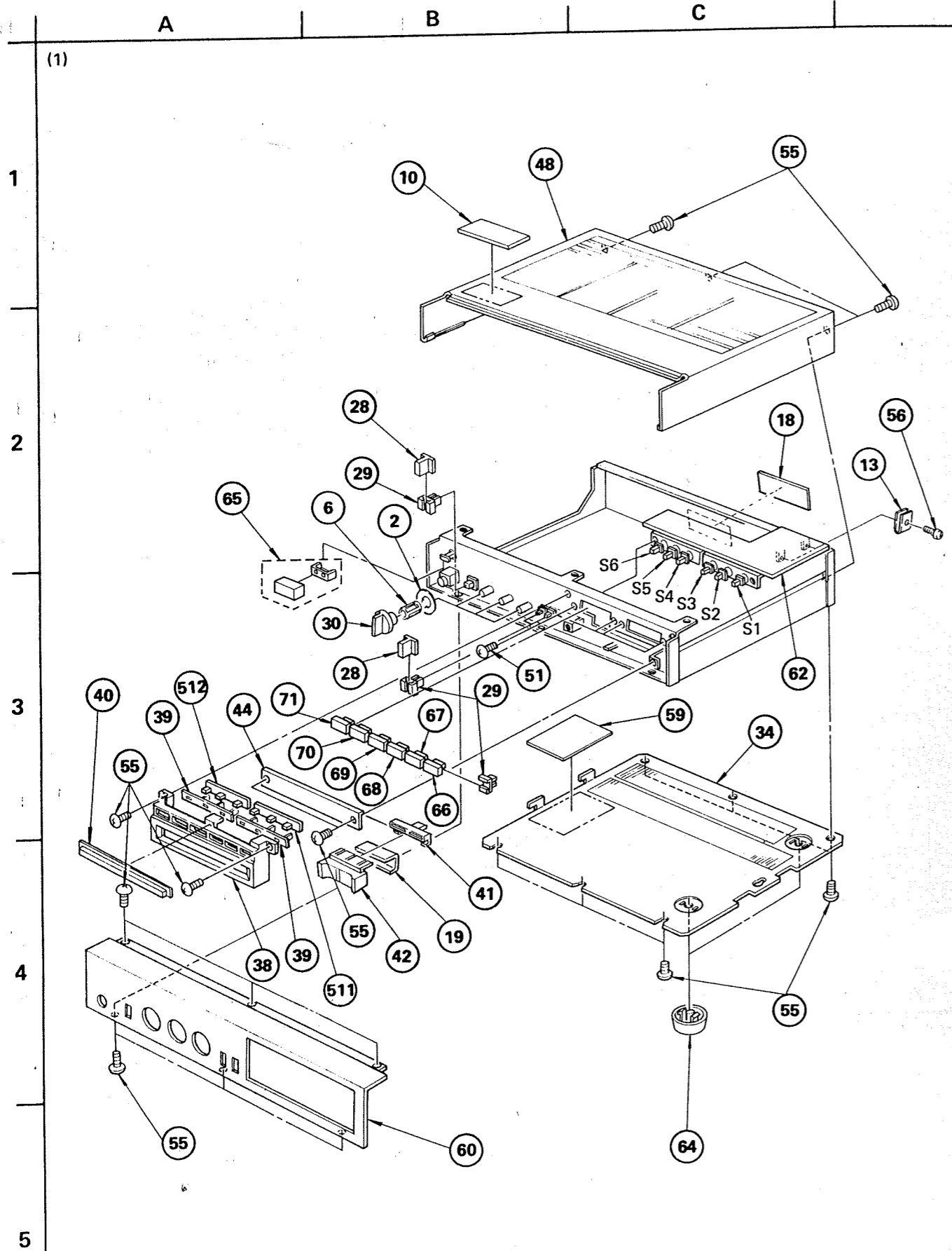

MYLAR CAPACITORS

CAP. (μF)	RATING			CAP. (μF)	RATING			CAP. (μF)	RATING		
	50 VOLT. PART No.	100 VOLT. PART No.	200 VOLT. PART No.		50 VOLT. PART No.	100 VOLT. PART No.	200 VOLT. PART No.		50 VOLT. PART No.	100 VOLT. PART No.	200 VOLT. PART No.
0.001	1-108-227-00	1-108-365-00	1-108-409-00	0.01	1-108-239-00	1-108-377-00	1-108-421-00	0.1	1-108-251-00	1-108-389-00	1-108-433-00
0.0012	1-108-351-00	1-108-366-00	1-108-410-00	0.012	1-108-357-00	1-108-378-00	1-108-422-00	0.12	1-108-363-00	1-108-390-00	1-108-434-00
0.0015	1-108-228-00	1-108-367-00	1-108-411-00	0.015	1-108-240-00	1-108-379-00	1-108-423-00	0.15	1-108-252-00	1-108-391-00	1-108-435-00
0.0018	1-108-352-00	1-108-368-00	1-108-412-00	0.018	1-108-358-00	1-108-380-00	1-108-424-00	0.18	1-108-364-00	1-108-392-00	1-108-436-00
0.0022	1-108-230-00	1-108-369-00	1-108-413-00	0.022	1-108-242-00	1-108-381-00	1-108-425-00	0.22	1-108-254-00	1-108-393-00	1-108-437-00
0.0027	1-108-353-00	1-108-370-00	1-108-414-00	0.027	1-108-359-00	1-108-382-00	1-108-426-00	0.27	1-108-354-00	-	-
0.0033	1-108-232-00	1-108-371-00	1-108-415-00	0.033	1-108-244-00	1-108-383-00	1-108-427-00	0.33	1-108-855-00	-	-
0.0039	1-108-354-00	1-108-372-00	1-108-416-00	0.039	1-108-360-00	1-108-384-00	1-108-428-00	0.39	1-108-856-00	-	-
0.0047	1-108-234-00	1-108-373-00	1-108-417-00	0.047	1-108-246-00	1-108-385-00	1-108-429-00	0.47	1-108-857-00	-	-
0.0056	1-108-355-00	1-108-374-00	1-108-418-00	0.056	1-108-361-00	1-108-386-00	1-108-430-00	-	-	-	-
0.0068	1-108-237-00	1-108-375-00	1-108-419-00	0.068	1-108-249-00	1-108-387-00	1-108-431-00	-	-	-	-
0.0082	1-108-356-00	1-108-376-00	1-108-420-00	0.082	1-108-362-00	1-108-388-00	1-108-432-00	-	-	-	-

TANTALUM CAPACITORS

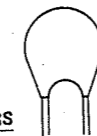

→ Use the high voltage rated one.

CAP. (μF)	RATING						
	3.15 VOLT. PART No.	6.3 VOLT. PART No.	10 VOLT. PART No.	16 VOLT. PART No.	20 VOLT. PART No.	25 VOLT. PART No.	35 VOLT. PART No.
0.01							1-131-396-00
0.015							1-131-397-00
0.022							1-131-398-00
0.033							1-131-399-00
0.047							1-131-400-00
0.068							1-131-401-00
0.1							1-131-402-00
0.15							1-131-403-00
0.22							1-131-404-00
0.33						1-131-409-00	1-131-405-00
0.47					1-131-412-00		1-131-406-00
0.68				1-131-415-00		1-131-410-00	1-131-407-00
1.0			1-131-418-00	1-131-413-00			1-131-408-00
1.5				1-131-416-00		1-131-411-00	1-131-348-00
2.2	1-131-424-00		1-131-419-00		1-131-414-00	1-131-355-00	1-131-349-00
3.3		1-131-422-00		1-131-417-00	1-131-362-00	1-131-356-00	1-131-350-00
4.7	1-131-425-00		1-131-420-00	1-131-369-00	1-131-363-00	1-131-357-00	1-131-351-00
6.8		1-131-423-00	1-131-376-00	1-131-370-00	1-131-364-00	1-131-358-00	1-131-352-00
10	1-131-426-00	1-131-383-00	1-131-377-00	1-131-371-00	1-131-365-00	1-131-359-00	1-131-353-00
15	1-131-390-00	1-131-384-00	1-131-378-00	1-131-372-00	1-131-366-00		
22	1-131-391-00	1-131-385-00	1-131-379-00	1-131-373-00	1-131-367-00		
33	1-131-392-00	1-131-386-00	1-131-380-00	1-131-374-00			
47	1-131-393-00	1-131-387-00	1-131-381-00				
68	1-131-394-00	1-131-388-00					
100	1-131-395-00						

TANTALUM CAPACITORS



CAP. (μF)	RATING					
	3 VOLT. PART No.	6.3 VOLT. PART No.	10 VOLT. PART No.	16 VOLT. PART No.	20 VOLT. PART No.	35 VOLT. PART No.
0.033						1-131-273-00
0.047						1-131-274-00
0.068						1-131-275-00
0.1						1-131-276-00
0.15						1-131-277-00
0.22					1-131-262-00	1-131-278-00
0.33					1-131-263-00	1-131-279-00
0.47			1-131-169-00		1-131-264-00	1-131-280-00
0.68				1-131-258-00	1-131-265-00	1-131-281-00
1.0			1-131-254-00		1-131-266-00	1-131-282-00
1.5		1-131-250-00			1-131-267-00	1-131-283-00
2.2				1-131-259-00	1-131-268-00	1-131-284-00
3.3			1-131-255-00		1-131-269-00	
4.7		1-131-251-00	1-131-171-00		1-131-270-00	
6.8				1-131-260-00	1-131-271-00	
10			1-131-256-00		1-131-272-00	
15		1-131-252-00		1-131-261-00		
22			1-131-257-00			
33	1-131-176-00	1-131-253-00	1-131-173-00			
47	1-131-288-00	1-131-174-00				
100	1-131-177-00					

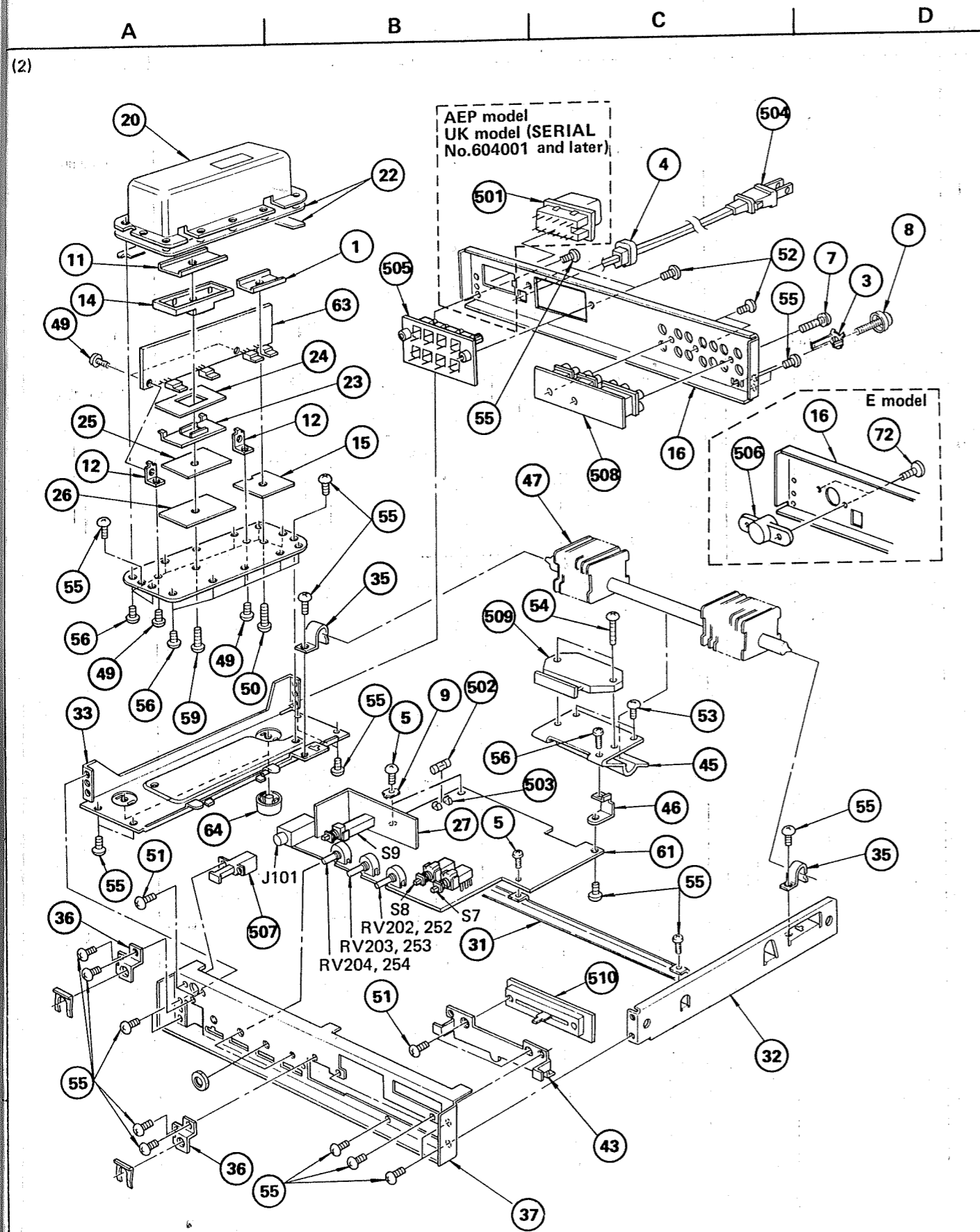

GENERAL SECTION

No.	Part No.	Description
1	2-275-902-00	BRACKET, TRANSISTOR
2	3-533-938-00	CLOTH
3	3-701-993-00	SPACER, TERMINAL
4	3-703-244-00	BUSHING, CORD
5	3-703-249-01	SCREW, S TIGHT, +PTTWH 3X6
6	3-703-466-00	SPRING (6600)
7	3-703-473-00	SCREW, TERMINAL
8	3-706-165-00	SCREW
9	4-835-639-00	PLATE, GROUND
10	4-861-045-00	LABEL, CAUTION
11	4-862-237-00	BRACKET, INVERTER
12	4-863-510-00	BRACKET, PC BOARD
13	4-866-080-00	HEAT SINK
14	4-866-315-00	RETAINER, TRANSISTOR
15	4-869-232-00	SHEET, INSULATING
16	4-875-101-00	(UK, UP TO SERIAL No. 604,000).....PLATE, JACK
16	4-875-101-11	(UK, SERIAL No. 604001 AND LATER)..PLATE, JACK
16	4-875-102-00	(E).....PLATE, JACK
16	4-875-103-00	(AEP).....PLATE, JACK
17
18	4-875-110-00	(AEP).....LABEL, SPECIFICATION
18	4-875-111-00	(UK).....LABEL, SPECIFICATION
18	4-875-112-00	(E1).....LABEL, SPECIFICATION
18	4-875-113-00	(E2).....LABEL, SPECIFICATION
18	4-875-113-11	(E2).....LABEL, SPECIFICATION
19	4-875-137-00	MOLD (B), CONTROL KNOB
20	4-875-139-00	BOX, POWER
21	4-875-140-00	HEAT SINK (P)
22	4-875-141-00	PACKING, SHIELD
23	4-875-142-00	HEAT SINK (W)
24	4-875-143-00	SARCON, TRANSISTOR
25	4-875-144-01	SHEET (E), INSULATING
26	4-875-144-11	SHEET (E), INSULATING
27	4-875-147-00	PLATE (B), SHIELD
28	4-875-150-00	KNOB, F
29	4-875-151-00	JOINT (F), KNOB
30	4-875-152-00	KNOB, CONTROL
31	4-875-153-00	CHANNEL (B)
32	4-875-154-00	PLATE, SIDE
33	4-875-155-00	PLATE, SIDE, L
34	4-875-156-00	PLATE, BOTTOM
35	4-875-157-00	HOLDER, PIPE
36	4-875-158-00	BRACKET, JACK
37	4-875-160-00	PANEL (C), SUB
38	4-875-163-00	ESCUTCHEON, CONTROL
39	4-875-164-00	FRAME, LED
40	4-875-165-00	WINDOW, F INDICATOR

GENERAL SECTION

No.	Part No.	Description
41	4-875-166-00	MOLD, CONTROL KNOB
42	4-875-167-00	KNOB, CONTROL
43	4-875-168-00	BRACKET, BACK PLATE
44	4-875-169-00	PLATE, BACK
45	4-875-170-00	BLOCK, POWER
46	4-875-171-00	BRACKET (C), PC BOARD
47	4-875-172-00	PIPE (C), HEAT
48	4-875-173-00	COVER, TOP
49	7-682-547-09	SCREW +B 3X6
50	7-682-551-09	SCREW +B 3X14
51	7-682-647-01	SCREW +PS 3X6
52	7-685-646-11	SCREW +BVTP 3X8 TYPE2 N-S
53	7-685-646-29	SCREW +BVTP 3X8 TYPE2 SLIT
54	7-685-650-29	SCREW +BVTP 3X16 TYPE2 SLIT
55	7-685-871-01	SCREW +BVTT 3X6 (S)
56	7-685-872-01	SCREW +BVTT 3X8 (S)
57	7-685-873-01	SCREW +BVTT 3X10 (S)
58	9-911-840-XX	SPACER (B), RUBBER
59	9-911-863-XX	INSULATOR
60	A-4322-325-A	PANEL ASSY
61	A-4335-160-A	(AEP).....MOUNTED PCB, AUDIO
61	A-4335-161-A	(UK).....MOUNTED PCB, AUDIO
61	A-4335-181-A	(E).....MOUNTED PCB, AUDIO
62	A-4358-086-A	(AEP,UK)...MOUNTED PCB, EQ
62	A-4358-090-A	(E).....MOUNTED PCB, EQ
63	A-4394-243-A	(AEP,UK)...MOUNTED PCB, PPS
63	A-4394-255-A	(E).....MOUNTED PCB, PPS
64	X-3701-069-0	FOOT ASSY, M.F
65	X-4875-108-0	KNOB ASSY, POWER
66	X-4875-116-0	KNOB ASSY, PHONO
67	X-4875-117-0	KNOB ASSY, TUNER
68	X-4875-118-0	KNOB ASSY, AUX
69	X-4875-119-0	KNOB ASSY, TAPE (1)
70	X-4875-120-0	KNOB ASSY, TAPE (2)
71	X-4875-121-0	KNOB ASSY, TAPE COPY
72	7-621-259-45	SCREW +P 2.6X6

NOTE:

- Items with no part number and no description are not stocked because they are seldom required for routine service.
- Items marked "▲" are not stocked since they are seldom required for routine service. Some delay should be anticipated when ordering these items.
- Due to standardization, parts with part numbers (Δ-ΔΔΔ-ΔΔΔ-XX or Δ-ΔΔΔΔ-ΔΔΔ-X) may be different from those used in the set.

CAPACITORS:

- All capacitors are in μF. Common capacitors are omitted. Refer to the following lists for their part numbers. MF:μF, PF:μμF.

RESISTORS

- All resistors are in ohms. Common 1/4W, 1/8W and 1/16W carbon resistors are omitted. Refer to the following lists for their part numbers.

COILS

- MMH : mH, UH : μH

ACCESSORY & PACKING MATERIAL

ELECTRICAL PARTS

No.	Part No.	Description
91	1-526-565-00	(E1)...ADAPTOR, AC PLUG
92	3-701-630-00	BAG, POLYETHYLENE
93	3-783-514-11	MANUAL, INSTRUCTION
94	3-795-182-11	(AEP,UK)...INSTRUCTION (DUTCH, SWEDISH)
95	4-866-723-00	SHEET, POLYETHYLENE
96	4-875-444-00	(AEP).....INDIVIDUAL CARTON (MADE IN KOREA)
96	4-875-445-00	(UK).....INDIVIDUAL CARTON (MADE IN KOREA)
96	4-875-447-00	(AEP,UK,E)...INDIVIDUAL CARTON (MADE IN JAPAN)
97	4-875-448-00	CUSHION, UPPER
98	4-875-449-00	CUSHION, LOWER

Ref.No.	Part No.	Description
501	▲.1-526-636-13	(UK,SERIAL No.604001 AND LATER) OUTLET, AC
501	▲.1-526-694-00	(AEP).....OUTLET, AC
502	▲.1-532-286-00	(AEP,UK)....TIME-LAG FUSE 2.5A
502	▲.1-532-350-00	(E).....TIME-LAG FUSE; 4A
503	▲.1-533-131-00	HOLDER, FUSE
504	▲.1-534-817-XX	(AEP).....CORD, POWER
504	▲.1-551-473-31	(E).....CORD, POWER
504	▲.1-551-884-00	(UK).....CORD, POWER
505	1-536-662-00	TERMINAL BOARD (SPEAKER)
506	▲.1-552-963-00	(E).....SWITCH, VOLTAGE SELECTOR
507	▲.1-553-447-00	SWITCH, PUSH (AC POWER)
508	▲.1-604-865-00	(AEP,UK)....PC BOARD, INPUT
508	▲.1-605-981-00	(E).....PC BOARD, INPUT
509	▲.1-604-866-00	(AEP,UK)....PC BOARD, POWER
509	▲.1-605-982-00	(E).....PC BOARD, POWER
510	▲.1-604-867-00	(AEP,UK)....PC BOARD, VOLUME
510	▲.1-605-983-00	(E).....PC BOARD, VOLUME
511	▲.1-604-868-00	(AEP,UK)....PC BOARD, DISPLAY (A)
511	▲.1-605-984-00	(E).....PC BOARD, DISPLAY (A)
512	▲.1-604-869-00	(AEP,UK)....PC BOARD, DISPLAY (B)
512	▲.1-605-985-00	(E).....PC BOARD, DISPLAY (B)
C416	▲.1-125-222-00	(AEP,UK).ELECT(BLOCK) 330MF 20% 400V
C416	▲.1-125-272-00	(E).....ELECT 560MF 20% 200V
C417	▲.1-130-701-00	(AEP,UK).FILM 0.47MF 20% 300V
C417	▲.1-130-234-00	(E).....FILM 0.047MF 20% 300V
C418	▲.1-161-734-00	(AEP,UK).CERAMIC 0.0022MF 20% 400V
C418	▲.1-161-741-00	(E).....CERAMIC 0.001MF 10% 400V
C419	▲.1-161-734-00	(AEP,UK).CERAMIC 0.0022MF 20% 400V
C420	▲.1-161-734-00	(AEP,UK).CERAMIC 0.0022MF 20% 400V
C420	▲.1-161-741-00	(E).....CERAMIC 0.001MF 10% 400V
C421	▲.1-161-734-00	(AEP,UK).CERAMIC 0.0022MF 20% 400V
C422	▲.1-130-234-00	(E).....FILM 0.047MF 20% 300V
C423	▲.1-125-272-00	(E).....ELECT 560MF 20% 200V
C901	▲.1-130-141-00	MYLAR 0.01MF 20% 630V
C902	▲.1-161-734-00	CERAMIC 0.0022MF 20% 400V
C903	▲.1-161-734-00	CERAMIC 0.0022MF 20% 400V
C904	▲.1-123-290-00	ELECT 10MF 400V
C905	▲.1-130-700-00	FILM 0.22MF 10% 250V
C906	▲.1-130-700-00	FILM 0.22MF 10% 250V
C907	▲.1-108-246-00	MYLAR 0.047MF 10% 50V
C908	▲.1-108-249-00	MYLAR 0.068MF 10% 50V
C909	▲.1-123-361-00	ELECT 220MF 50V
C910	▲.1-123-361-00	ELECT 220MF 50V
C911	▲.1-123-361-00	ELECT 220MF 20% 50V
C912	▲.1-123-361-00	ELECT 220MF 20% 50V

NOTE:

- Items with no part number and no description are not stocked because they are seldom required for routine service.
- Items marked "▲" are not stocked since they are seldom required for routine service. Some delay should be anticipated when ordering these items.
- Due to standardization, parts with part numbers (▲-▲▲▲-▲▲▲-XX or ▲-▲▲▲-▲▲▲-X) may be different from those used in the set.

CAPACITORS:

- All capacitors are in μ F. Common capacitors are omitted. Refer to the following lists for their part numbers. MF: μ F, PF: μ F.

RESISTORS

- All resistors are in ohms. Common 1/4W, 1/8W and 1/16W carbon resistors are omitted. Refer to the following lists for their part numbers.

- F : nonflammable

The components identified by shading and mark ▲ are critical for safety. Replace only with part number specified.

COILS

- MMH : mH, UH : μ H

ELECTRICAL PARTS

Ref.No.	Part No.	Description
C913	▲.1-108-246-00	MYLAR 0.047MF 10% 50V
C914	▲.1-130-141-00	MYLAR 0.01MF 20% 630V
C915	▲.1-161-734-00	(AEP,UK).CERAMIC 0.0022MF 20% 400V
C916	▲.1-161-734-00	(AEP,UK).CERAMIC 0.0022MF 20% 400V
CNJ101		
CNJ102		
CNJ103	1-507-741-21	JACK, PIN 6P; PHONO, TUNER, AUX
CNJ151		
CNJ152		
CNJ153		
CNJ104		
CNJ105	1-507-740-00	JACK, PIN 4P; TAPE RECORDER 1/2
CNJ154		
CNJ155		
D001	8-719-912-55	DIODE SLP255B
D002	8-719-912-55	DIODE SLP255B
D003	8-719-912-55	DIODE SLP255B
D004	8-719-912-55	DIODE SLP255B
D005	8-719-912-55	DIODE SLP255B
D006	8-719-921-55	DIODE SLP155B
D007	8-719-144-07	DIODE RD2.4E-B
D301	8-719-815-55	DIODE 1S1555
D302	8-719-910-63	DIODE HZ6A3L
D303	8-719-422-21	DIODE 1T22AM
D304	8-719-815-55	DIODE 1S1555
D305	8-719-422-21	DIODE 1T22AM
D306	8-719-815-55	DIODE 1S1555
D351	8-719-910-63	DIODE HZ6A3L
D353	8-719-422-21	DIODE 1T22AM
D354	8-719-815-55	DIODE 1S1555
D355	8-719-422-21	DIODE 1T22AM
D356	8-719-815-55	DIODE 1S1555
D401	8-719-910-63	DIODE HZ6A3L
D402	8-719-815-55	DIODE 1S1555
D403	8-719-127-26	DIODE RD27E-B3Z
D404	▲.8-719-230-24	DIODE 30DL4FA
D405	▲.8-719-230-24	DIODE 30DL4FA
D406	▲.8-719-230-24	DIODE 30DL4FA
D407	▲.8-719-230-24	DIODE 30DL4FA
D901	▲.8-719-815-55	DIODE 1S1555
D902	▲.8-719-815-55	DIODE 1S1555
D903	▲.8-719-300-22	DIODE CTU-22U
D904	▲.8-719-300-22	DIODE CTU-22U
F2	▲.1-532-556-00	FUSE, TEMPERATURE
IC101	8-759-305-50	IC CX-550
IC151	8-759-305-50	IC CX-550
IC201	8-759-745-60	IC NJM4560D
IC301	8-759-822-30	IC STK-2230ST
IC401	8-759-320-02	IC HA12002
J101	1-507-669-00	JACK

NOTE:

- Items with no part number and no description are not stocked because they are seldom required for routine service.
- Items marked "▲" are not stocked since they are seldom required for routine service. Some delay should be anticipated when ordering these items.
- Due to standardization, parts with part numbers (▲-▲▲▲-▲▲▲-XX or ▲-▲▲▲-▲▲▲-X) may be different from those used in the set.

CAPACITORS:

- All capacitors are in μ F. Common capacitors are omitted. Refer to the following lists for their part numbers. MF: μ F, PF: μ F.

RESISTORS

- All resistors are in ohms. Common 1/4W, 1/8W and 1/16W carbon resistors are omitted. Refer to the following lists for their part numbers.

- F : nonflammable

ELECTRICAL PARTS

Ref.No.	Part No.	Description
L301	▲.1-420-872-00	COIL, AIRE CORE
L351	▲.1-420-872-00	COIL, AIRE CORE
L901	▲.1-421-340-00	LINE FILTER
L902	▲.1-421-329-00	COIL, CHOKE
L903	▲.1-421-329-00	COIL, CHOKE
L904	▲.1-421-329-00	COIL, CHOKE
L905	▲.1-421-329-00	COIL, CHOKE
L906	▲.1-421-329-00	COIL, CHOKE
Q301	8-729-679-82	TRANSISTOR 2SA798-G
Q302	8-729-629-12	TRANSISTOR 2SC2291-G
Q303	8-729-304-62	TRANSISTOR 2SB646-A
Q304	8-729-300-62	TRANSISTOR 2SD666-A
Q305	8-729-201-52	TRANSISTOR 2SA1015-GR
Q306	8-729-663-47	TRANSISTOR 2SC1364
Q307	8-729-663-47	TRANSISTOR 2SC1364
Q308	8-729-201-52	TRANSISTOR 2SA1015-GR
Q351	8-729-679-82	TRANSISTOR 2SA798-G
Q352	8-729-629-12	TRANSISTOR 2SC2291-G
Q353	8-729-304-62	TRANSISTOR 2SB646-A
Q354	8-729-300-62	TRANSISTOR 2SD666-A
Q355	8-729-201-52	TRANSISTOR 2SA1015-GR
Q356	8-729-663-47	TRANSISTOR 2SC1364
Q357	8-729-663-47	TRANSISTOR 2SC1364
Q358	8-729-201-52	TRANSISTOR 2SA1015-GR
Q401	8-729-180-93	TRANSISTOR 2SD809-K
Q402	8-729-173-13	TRANSISTOR 2SB731-K
Q403	8-729-663-47	TRANSISTOR 2SC1364
Q404	8-729-201-52	TRANSISTOR 2SA1015-GR
Q405	8-729-224-61	TRANSISTOR 2SK246-Y
Q406	8-729-224-61	TRANSISTOR 2SK246-Y
Q901	▲.8-729-612-77	TRANSISTOR 2SA1027R
Q902	▲.8-729-663-47	TRANSISTOR 2SC1364
Q903	▲.X-4869-209-1	TRANSISTOR ASSY, SERVICE 2SC2767
Q904	▲.X-4869-209-1	TRANSISTOR ASSY, SERVICE 2SC2767
R000	▲.1-205-599-00	CEMENT-COATED 75 10% 5W
R007	▲.1-206-668-00	METAL 1.5K 5% 2W F
R313	▲.1-247-107-00	CARBON 100 5% 1/4W F
R314	▲.1-247-107-00	CARBON 100 5% 1/4W F
R315	▲.1-247-107-00	CARBON 100 5% 1/4W F
R320	1-217-152-00	RES, METAL PLATE 0.33
R321	▲.1-247-192-00	CARBON 10 5% 1/2W F
R363	▲.1-247-107-00	CARBON 100 5% 1/4W F
R364	▲.1-247-107-00	CARBON 100 5% 1/4W F
R365	▲.1-247-107-00	CARBON 100 5% 1/4W F
R370	1-217-152-00	RES, METAL PLATE 0.33
R371	▲.1-247-192-00	CARBON 10 5% 1/2W F
R406	▲.1-212-857-00	FUSIBLE 10 5% 1/4W F
R407	▲.1-212-857-00	FUSIBLE 10 5% 1/4W F
R414	1-206-670-00	METAL 1.8K 5% 2W F
R416	▲.1-246-529-00	(E)....CARBON 220K 5% 1/4W
R417	▲.1-246-529-00	(E)....CARBON 220K 5% 1/4W

The components identified by shading and mark ▲ are critical for safety. Replace only with part number specified.

COILS

- MMH : mH, UH : μ H

ELECTRICAL PARTS

Ref.No. Part No. Description

R901	△ 1-244-928-00	CARBON 200K 15%	1/2W
R902	△ 1-246-483-00	CARBON 2.7K 5%	1/4W
R903	△ 1-246-483-00	CARBON 2.7K 5%	1/4W
R904	△ 1-246-507-00	CARBON 2.7K 5%	1/4W
R905	△ 1-246-469-00	CARBON 680 5%	1/4W
R906	△ 1-244-822-00	CARBON 7.5 5%	1/2W

RT301	1-226-232-00	RES, ADJ, CARBON 500; DC BALANCE
RT351	1-226-232-00	RES, ADJ, CARBON 500; DC BALANCE

RV201	1-228-249-00	RES, VAR, SLIDE 250K; VOLUME
RV202	1-228-245-00	RES, VAR, CARBON 250K/250K; BALANCE
RV203	1-228-247-00	RES, VAR, CARBON 50K/50K; TREBLE
RV204	1-228-248-00	RES, VAR, CARBON 50K/50K; BASS
RV251	1-228-249-00	RES, VAR, SLIDE 250K; VOLUME

RV252	1-228-245-00	RES, VAR, CARBON 250K/250K; BALANCE
RV253	1-228-247-00	RES, VAR, CARBON 50K/50K; TREBLE
RV254	1-228-248-00	RES, VAR, CARBON 50K/50K; BASS

RY401	1-515-348-00	RELAY
RY402	△ 1-515-347-00	RELAY (E).....RELAY
RY901	△ 1-515-349-00	(E).....RELAY

S1	1-553-721-00	SWITCH, PUSH; PHONO
S2	1-553-721-00	SWITCH, PUSH; TUNER
S3	1-553-721-00	SWITCH, PUSH; AUX
S4	1-553-722-00	SWITCH, PUSH; TAPE1
S5	1-553-722-00	SWITCH, PUSH; TAPE2

S6	1-553-722-00	SWITCH, PUSH; TAPE COPY 1-2
S7	1-553-138-00	SWITCH, PUSH; LOUDNESS
S8	1-553-138-00	SWITCH, PUSH; SUBSONIC
S9	1-553-724-00	SWITCH, ROTARY SLIDE; SPEAKERS

T901	△ 1-543-100-00	CORE
T902	△ 1-543-100-00	CORE
T903	△ 1-446-964-00	TRANSFORMER, CONVERTER

NOTE:
 * Items with no part number and no description are not stocked because they are seldom required for routine service.
 * Items marked "△" are not stocked since they are seldom required for routine service. Some delay should be anticipated when ordering these items.
 * Due to standardization, parts with part numbers (Δ-ΔΔΔ-ΔΔΔ-XX or Δ-ΔΔΔΔ-ΔΔΔ-X) may be different from those used in the set.

CAPACITORS:
 * All capacitors are in μF. Common capacitors are omitted. Refer to the following lists for their part numbers. MF:μF, PF:μF.

RESISTORS
 * All resistors are in ohms. Common 1/4W, 1/8W and 1/16W carbon resistors are omitted. Refer to the following lists for their part numbers.

* F : nonflammable

The components identified by shading and mark △ are critical for safety. Replace only with part number specified.

COILS
 * MMH : mH, UH : μH

ELECTROLYTIC CAPACITORS

CAP. (μF)	RATING → Use the high voltage rated one.					
	6.3 VOLT.	10 VOLT.	16 VOLT.	25 VOLT.	35 VOLT.	50 VOLT.
	PART No.	PART No.	PART No.	PART No.	PART No.	PART No.
0.47						1-121-726-00
1.0						1-121-391-00
2.2						1-121-450-00
3.3	→	→	→	1-121-392-00		1-121-393-00
4.7	→	→	→	1-121-395-00		1-121-396-00
10	→	→	1-121-651-00	1-121-398-00		1-121-738-00
22	→	→	1-121-479-00	1-121-480-00		1-121-152-00
33	→	→	1-121-403-00	1-121-404-00	1-121-662-00	1-121-405-00
47	→	1-121-352-00	1-121-409-00	1-121-410-00	1-121-652-00	1-121-411-00
100	→	1-121-414-00	1-121-415-00	1-121-416-00	1-121-653-00	1-121-417-00
220	1-121-419-00	1-121-420-00	1-121-421-00	1-121-422-00	1-121-261-00	1-121-423-00
330	1-121-751-00	1-121-805-00	1-121-521-00	1-121-654-00	1-121-655-00	1-121-656-00
470	1-121-424-00	1-121-425-00	1-121-426-00	1-121-733-00	1-121-361-00	1-121-810-00
1000		1-121-736-00	1-121-245-00	1-121-657-00	1-121-388-00	1-123-061-00
2200	1-121-658-00	1-121-659-00	1-121-660-00	1-123-067-00	1-121-984-00	
3300	1-121-661-00	1-123-075-00	1-123-071-00			

CAP. (μF)	100 VOLT.	160 VOLT.	250 VOLT.	350 VOLT.
	PART No.	PART No.	PART No.	PART No.
0.47				
1.0	1-123-249-00	1-123-252-00	1-123-003-00	1-121-168-00
2.2	1-123-250-00	1-123-026-00		1-123-028-00
3.3	1-121-995-00		1-123-004-00	1-123-006-00
4.7	1-123-255-00	1-121-246-00	1-121-759-00	1-123-007-00
10	1-121-126-00	1-121-999-00	1-123-254-00	1-123-008-00
22	1-121-996-00	1-123-253-00	1-123-005-00	1-123-022-00
33	1-121-997-00	1-121-757-00		
47	1-123-251-00	1-121-919-00		
100	1-123-084-00			

CERAMIC CAPACITORS

CAP. (pF)	RATING						
	50 VOLT.	CAP. (pF)	50 VOLT.	50 VOLT.	CAP. (pF)	50 VOLT.	50 VOLT.
	PART No.		PART No.	PART No.	PART No.	PART No.	PART No.
0.5	1-101-837-00	22	1-102-959-00	150	1-101-361-00	0.001	1-102-074-00
0.75	1-101-586-00	24	1-102-960-00	160	1-101-367-00	0.0012	1-102-118-00
1.0	1-102-934-00	27	1-102-961-00	180	1-102-976-00	0.0015	1-102-119-00
1.5	1-101-576-00	30	1-102-962-00	200	1-102-977-00	0.0018	1-102-120-00
2.0	1-102-935-00	33	1-102-963-00	220	1-102-978-00	0.0022	1-102-121-00
3	1-102-936-00	36	1-102-964-00	240	1-102-979-00	0.0027	1-102-122-00
4	1-102-937-00	39	1-102-965-00	270	1-102-980-00	0.0033	1-102-123-00
5	1-102-942-00	43	1-102-966-00	300	1-102-981-00	0.0039	1-102-124-00
6	1-102-943-00	47	1-101-880-00	330	1-102-820-00	0.0047	1-102-125-00
7	1-102-944-00	51	1-101-882-00	360	1-102-821-00	0.0056	1-102-126-00
8	1-102-945-00	56	1-101-884-00	390	1-102-822-00	0.0068	1-102-127-00
9	1-102-946-00	62	1-101-886-00	430	1-102-823-00	0.0082	1-102-128-00
10	1-102-947-00	68	1-101-888-00	470	1-102-824-00	0.01	1-102-129-00
11	1-102-948-00	75	1-101-890-00	510	1-101-059-00	0.022	1-101-005-00
12	1-102-949-00	82	1-102-971-00	560	1-102-115-00	0.047	1-101-006-00
13	1-102-950-00	91	1-102-972-00	680	1-102-116-00		
15	1-102-951-00	100	1-102-973-00	820	1-102-117-00		
16	1-102-952-00	110	1-102-815-00				
18	1-102-953-00	120	1-102-816-00				
20	1-102-958-00	130	1-101-081-00				

0.001μF = 1,000pF

CERAMIC (SEMICONDUCTOR) CAPACITORS

CAP. (μF)	RATING → Use the high voltage rated one.					
	25 VOLT.	50 VOLT.	CAP. (μF)	25 VOLT.	50 VOLT.	
	PART No.	PART No.		PART No.	PART No.	
0.001	→	1-161-039-00	0.018	1-161-016-00	1-161-054-00	
0.0012	→	1-161-040-00	0.022	1-161-017-00	1-161-055-00	
0.0015		1-161-041-00	0.027	1-161-018-00	1-161-056-00	
0.0018		1-161-042-00	0.033	1-161-019-00	1-161-057-00	
0.0022		1-161-043-00	0.039	1-161-010-00	1-161-058-00	
0.0027	→	1-161-044-00	0.047	1-161-021-00	1-161-059-00	
0.0033	→	1-161-045-00	0.056	→	1-161-060-00	
0.0039	→	1-161-046-00	0.068	→	1-161-061-00	
0.0047	→	1-161-047-00	0.082	1-161-024-00	1-161-062-00	
0.0056	→	1-161-048-00	0.1	1-161-025-00	1-161-063-00	
0.0068	→	1-161-049-00				
0.0082	1-161-012-00	1-161-050-00				
0.01	1-161-013-00	1-161-051-00				
0.012	→	1-161-052-00				
0.015	1-161-015-00	1-161-053-00				

MYLAR CAPACITORS

CAP. (μF)	RATING			CAP. (μF)	RATING			CAP. (μF)	RATING		
	50 VOLT. PART No.	100 VOLT. PART No.	200 VOLT. PART No.		50 VOLT. PART No.	100 VOLT. PART No.	200 VOLT. PART No.		50 VOLT. PART No.	100 VOLT. PART No.	200 VOLT. PART No.
0.001	1-108-227-00	1-108-365-00	1-108-409-00	0.01	1-108-239-00	1-108-377-00	1-108-421-00	0.1	1-108-251-00	1-108-389-00	1-108-433-00
0.0012	1-108-351-00	1-108-366-00	1-108-410-00	0.012	1-108-357-00	1-108-378-00	1-108-422-00	0.12	1-108-363-00	1-108-390-00	1-108-434-00
0.0015	1-108-228-00	1-108-367-00	1-108-411-00	0.015	1-108-240-00	1-108-379-00	1-108-423-00	0.15	1-108-252-00	1-108-391-00	1-108-435-00
0.0018	1-108-352-00	1-108-368-00	1-108-412-00	0.018	1-108-358-00	1-108-380-00	1-108-424-00	0.18	1-108-364-00	1-108-392-00	1-108-436-00
0.0022	1-108-230-00	1-108-369-00	1-108-413-00	0.022	1-108-242-00	1-108-381-00	1-108-425-00	0.22	1-108-254-00	1-108-393-00	1-108-437-00
0.0027	1-108-353-00	1-108-370-00	1-108-414-00	0.027	1-108-359-00	1-108-382-00	1-108-426-00	0.27	1-108-854-00	-	-
0.0033	1-108-232-00	1-108-371-00	1-108-415-00	0.033	1-108-244-00	1-108-383-00	1-108-427-00	0.33	1-108-855-00	-	-
0.0039	1-108-354-00	1-108-372-00	1-108-416-00	0.039	1-108-360-00	1-108-384-00	1-108-428-00	0.39	1-108-856-00	-	-
0.0047	1-108-234-00	1-108-373-00	1-108-417-00	0.047	1-108-246-00	1-108-385-00	1-108-429-00	0.47	1-108-857-00	-	-
0.0056	1-108-355-00	1-108-374-00	1-108-418-00	0.056	1-108-361-00	1-108-386-00	1-108-430-00	-	-	-	-
0.0068	1-108-237-00	1-108-375-00	1-108-419-00	0.068	1-108-249-00	1-108-387-00	1-108-431-00	-	-	-	-
0.0082	1-108-356-00	1-108-376-00	1-108-420-00	0.082	1-108-362-00	1-108-388-00	1-108-432-00	-	-	-	-

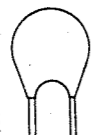

TANTALUM CAPACITORS

→ Use the high voltage rated one.

CAP. (μF)	RATING					
	3.15 VOLT. PART No.	6.3 VOLT. PART No.	10 VOLT. PART No.	16 VOLT. PART No.	20 VOLT. PART No.	35 VOLT. PART No.
0.01						1-131-396-00
0.015						1-131-397-00
0.022						1-131-398-00
0.033						1-131-399-00
0.047						1-131-400-00
0.068						1-131-401-00
0.1						1-131-402-00
0.15						1-131-403-00
0.22						1-131-404-00
0.33						1-131-405-00
0.47					1-131-412-00	1-131-406-00
0.68				1-131-415-00	1-131-410-00	1-131-407-00
1.0			1-131-418-00	1-131-413-00		1-131-408-00
1.5		1-131-421-00		1-131-416-00		1-131-409-00
2.2	1-131-424-00		1-131-419-00		1-131-414-00	1-131-410-00
3.3		1-131-422-00		1-131-417-00	1-131-362-00	1-131-356-00
4.7	1-131-425-00		1-131-420-00	1-131-369-00	1-131-363-00	1-131-357-00
6.8		1-131-423-00	1-131-376-00	1-131-370-00	1-131-364-00	1-131-351-00
10	1-131-426-00	1-131-383-00	1-131-377-00	1-131-371-00	1-131-365-00	1-131-352-00
15	1-131-390-00	1-131-384-00	1-131-378-00	1-131-372-00	1-131-366-00	1-131-353-00
22	1-131-391-00	1-131-385-00	1-131-379-00	1-131-373-00	1-131-367-00	
33	1-131-392-00	1-131-386-00	1-131-380-00	1-131-374-00		
47	1-131-393-00	1-131-387-00	1-131-381-00			
68	1-131-394-00	1-131-388-00				
100	1-131-395-00					

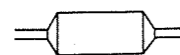

TANTALUM CAPACITORS

CAP. (μF)	RATING					
	3 VOLT. PART No.	6.3 VOLT. PART No.	10 VOLT. PART No.	16 VOLT. PART No.	20 VOLT. PART No.	35 VOLT. PART No.
0.033						1-131-273-00
0.047						1-131-274-00
0.068						1-131-275-00
0.1						1-131-276-00
0.15						1-131-277-00
0.22						1-131-262-00
0.33						1-131-263-00
0.47			1-131-169-00			1-131-279-00
0.68				1-131-258-00		1-131-280-00
1.0			1-131-254-00			1-131-281-00
1.5		1-131-250-00				1-131-282-00
2.2				1-131-259-00		1-131-267-00
3.3						1-131-268-00
4.7		1-131-251-00	1-131-171-00			1-131-269-00
6.8				1-131-260-00		1-131-270-00
10			1-131-256-00			1-131-271-00
15		1-131-252-00		1-131-261-00		1-131-272-00
22			1-131-257-00			
33	1-131-176-00	1-131-253-00	1-131-173-00			
47	1-131-288-00	1-131-174-00				
100	1-131-177-00					

1/4 WATT CARBON RESISTORS

Ω	Part No.	Ω	Part No.	Ω	Part No.	Ω	Part No.	Ω	Part No.	Ω	Part No.	Ω	Part No.
1.0	1-246-401-00	10	1-246-425-00	100	1-246-449-00	1.0k	1-246-473-00	10k	1-246-497-00	100k	1-246-521-00	1.0M	1-246-545-00
1.1	1-246-402-00	11	1-246-426-00	110	1-246-450-00	1.1k	1-246-474-00	11k	1-246-498-00	110k	1-246-522-00	1.1M	1-210-814-00
1.2	1-246-403-00	12	1-246-427-00	120	1-246-451-00	1.2k	1-246-475-00	12k	1-246-499-00	120k	1-246-523-00	1.2M	1-210-815-00
1.3	1-246-404-00	13	1-246-428-00	130	1-246-452-00	1.3k	1-246-476-00	13k	1-246-500-00	130k	1-246-524-00	1.3M	1-210-816-00
1.5	1-246-405-00	15	1-246-429-00	150	1-246-453-00	1.5k	1-246-477-00	15k	1-246-501-00	150k	1-246-525-00	1.5M	1-210-817-00
1.6	1-246-406-00	16	1-246-430-00	160	1-246-454-00	1.6k	1-246-478-00	16k	1-246-502-00	160k	1-246-526-00	1.6M	1-210-818-00
1.8	1-246-407-00	18	1-246-431-00	180	1-246-455-00	1.8k	1-246-479-00	18k	1-246-503-00	180k	1-246-527-00	1.8M	1-210-819-00
2.0	1-246-408-00	20	1-246-432-00	200	1-246-456-00	2.0k	1-246-480-00	20k	1-246-504-00	200k	1-246-528-00	2.0M	1-210-820-00
2.2	1-246-409-00	22	1-246-433-00	220	1-246-457-00	2.2k	1-246-481-00	22k	1-246-505-00	220k	1-246-529-00	2.2M	1-210-821-00
2.4	1-246-410-00	24	1-246-434-00	240	1-246-458-00	2.4k	1-246-482-00	24k	1-246-506-00	240k	1-246-530-00	2.4M	1-244-754-00
2.7	1-246-411-00	27	1-246-435-00	270	1-246-459-00	2.7k	1-246-483-00	27k	1-246-507-00	270k	1-246-531-00	2.7M	1-244-755-00
3.0	1-246-412-00	30	1-246-436-00	300	1-246-460-00	3.0k	1-246-484-00	30k	1-246-508-00	300k	1-246-532-00	3.0M	1-244-756-00
3.3	1-246-413-00	33	1-246-437-00	330	1-246-461-00	3.3k	1-246-485-00	33k	1-246-509-00	330k	1-246-533-00	3.3M	1-244-757-00
3.6	1-246-414-00	36	1-246-438-00	360	1-246-462-00	3.6k	1-246-486-00	36k	1-246-510-00	360k	1-246-534-00	3.6M	1-244-758-00
3.9	1-246-415-00	39	1-246-439-00	390	1-246-463-00	3.9k	1-246-487-00	39k	1-246-511-00	390k	1-246-535-00	3.9M	1-244-759-00
4.3	1-246-416-00	43	1-246-440-00	430	1-246-464-00	4.3k	1-246-488-00	43k	1-246-512-00	430k	1-246-536-00	4.3M	1-244-760-00
4.7	1-246-417-00	47	1-246-441-00	470	1-246-465-00	4.7k	1-246-489-00	47k	1-246-513-00	470k	1-246-537-00	4.7M	1-244-761-00
5.1	1-246-418-00	51	1-246-442-00	510	1-246-466-00	5.1k	1-246-490-00	51k	1-246-514-00	510k	1-246-538-00	5.1M	1-244-762-00
5.6	1-246-419-00	56	1-246-443-00	560	1-246-467-00	5.6k	1-246-491-00	56k	1-246-515-00	560k	1-246-539-00		
6.2	1-246-420-00	62	1-246-444-00	620	1-246-468-00	6.2k	1-246-492-00	62k	1-246-516-00	620k	1-246-540-00		
6.8	1-246-421-00	68	1-246-445-00	680	1-246-469-00	6.8k	1-246-493-00	68k	1-246-517-00	680k	1-246-541-00		
7.5	1-246-422-00	75	1-246-446-00	750	1-246-470-00	7.5k	1-246-494-00	75k	1-246-518-00	750k	1-246-542-00		
8.2	1-246-423-00	82	1-246-447-00	820	1-246-471-00	8.2k	1-246-495-00	82k	1-246-519-00	820k	1-246-543-00		
9.1	1-246-424-00	91	1-246-448-00	910	1-246-472-00	9.1k	1-246-496-00	91k	1-246-520-00	910k	1-246-544-00		

HARDWARE NOMENCLATURE

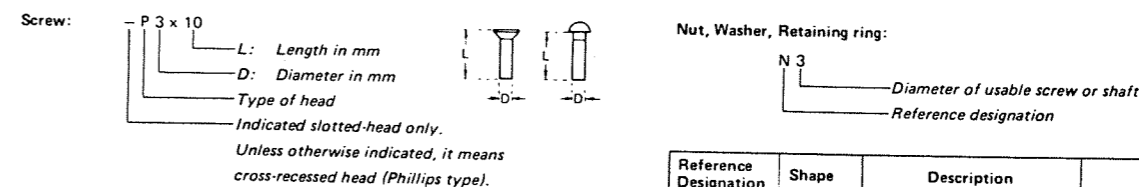

Reference Designation	Shape	Description	Remarks
SCREWS			
P		pan-head screw	binding-head (B) screw for replacement
PWH		pan-head screw with washer face	binding-head (B) screw and flat washer for replacement
PS		pan-head screw with spring washer	binding-head (B) screw and spring washer for replacement
PSP		pan-head screw with spring washer	binding-head (B) screw and spring washer for replacement
PSW		pan-head screw with spring and flat washers	binding-head (B) screw and spring and flat washers for replacement
PSPW		pan-head screw with spring and flat washers	binding-head (B) screw and spring and flat washers for replacement
R		round-head screw	binding-head (B) screw for replacement
K		flat-countersunk-head screw	
RK		oval-countersunk-head screw	
B		binding-head screw	
T		truss-head screw	binding-head (B) screw for replacement
F		flat-fillister-head screw	
RF		fillister-head screw	
BV		brazer-head screw	

Reference Designation	Shape	Description	Remarks
SELF-TAPPING SCREWS			
TA		self-tapping screw	ex: TA, P 3 x 10'
PTP		pan-head self-tapping screw	binding-head self-tapping (TA, B) screw for replacement
PTPWH		pan-head self-tapping screw with washer face	binding-head self-tapping (TA, B) screw and flat washer for replacement
PTTWH		pan-head thread-rolling screw with washer face	binding-head (B) screw and flat washer for replacement
SET SCREWS			
SC		set screw	
SC		hexagon-socket set screw	ex: SC 2.6 x 4, hexagon socket
NUT			
N		nut	
WASHERS			
W		flat washer	
SW		spring washer	
LW		internal-tooth lock washer	ex: LW3, internal
LW		external-tooth lock washer	ex: LW3, external
RETAINING RINGS			
E		retaining ring	
G		grip-type retaining ring	